



18V LITHIUM ION

115MM ANGLE GRINDER

INSTRUCTION MANUAL

SPECIFICATIONS

Voltage:	18V
No Load Speed:	8500/min
Disc Diameter:	115mm (4½")
Spindle:	M14
Weight:	1.8kg

ozito.com.au

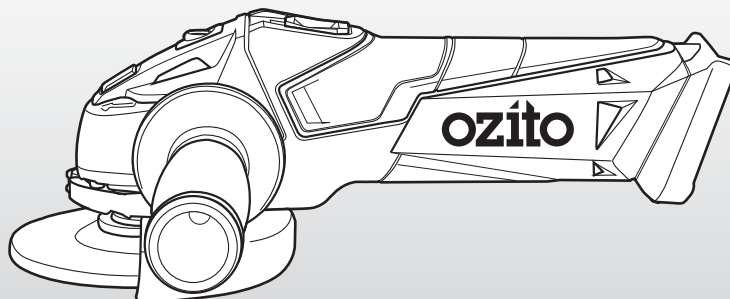

WHAT'S IN THE BOX

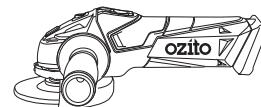

Angle Grinder

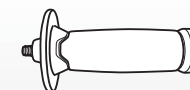

Side Handle



Safety Guard

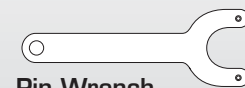

Pin Wrench

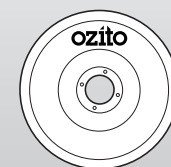

Grinding Disc

5 YEAR
REPLACEMENT WARRANTY

PXAGS-500

WARRANTY

IN ORDER TO MAKE A CLAIM UNDER THIS WARRANTY YOU MUST RETURN THE PRODUCT TO YOUR NEAREST BUNNINGS WAREHOUSE WITH YOUR BUNNINGS REGISTER RECEIPT. PRIOR TO RETURNING YOUR PRODUCT FOR WARRANTY PLEASE TELEPHONE OUR CUSTOMER SERVICE HELPLINE:

Australia 1800 069 486

New Zealand 0508 069 486

TO ENSURE A SPEEDY RESPONSE PLEASE HAVE THE MODEL NUMBER AND DATE OF PURCHASE AVAILABLE. A CUSTOMER SERVICE REPRESENTATIVE WILL TAKE YOUR CALL AND ANSWER ANY QUESTIONS YOU MAY HAVE RELATING TO THE WARRANTY POLICY OR PROCEDURE.

WARNING

The following actions will result in the warranty being void.

- If the tool has been operated on a supply voltage other than that specified on the tool.
- If the tool shows signs of damage or defects caused by or resulting from abuse, accidents or alterations.
- Failure to perform maintenance as set out within the instruction manual.
- If the tool is disassembled or tampered with in any way.

The benefits provided under this warranty are in addition to other rights and remedies which are available to you at law.

Our goods come with guarantees that cannot be excluded at law. You are entitled to a replacement or refund for a major failure and for compensation for any other reasonably foreseeable loss or damage. You are also entitled to have the goods repaired or replaced if the goods fail to be of acceptable quality and the failure does not amount to a major failure.

Generally you will be responsible for all costs associated with a claim under this warranty, however, where you have suffered any additional direct loss as a result of a defective product you may be able to claim such expenses by contacting our customer service helpline above.

5 YEAR REPLACEMENT WARRANTY

Your Product is guaranteed for a period of 60 months from the original date of purchase and is intended for DIY (Do It Yourself) use only. If a product is defective it will be replaced in accordance with the terms of this warranty. **Lithium Ion batteries and chargers are covered by a 36 month warranty** and are excluded from the warranty extension. Warranty excludes consumable parts.

KNOW YOUR PRODUCT

CORDLESS ANGLE GRINDER

- | | |
|------------------------|--------------------|
| 1 Spindle Lock | 5 Sure Grip Handle |
| 2 Guard Locking Screw | 6 Battery Seating |
| 3 Side Handle | 7 Pin Wrench |
| 4 Lock On Slide Switch | |

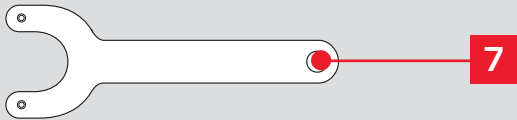
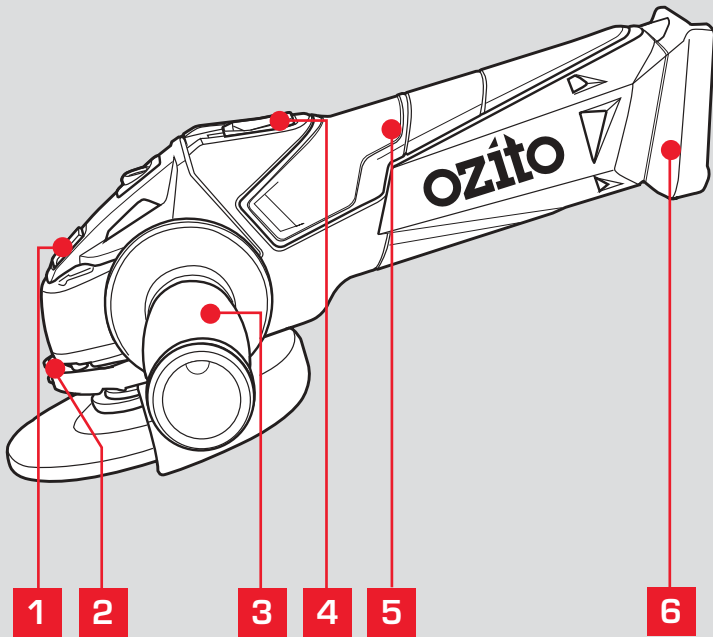

BATTERY & CHARGER

This tool is compatible with all battery and chargers from the Ozito Power X Change Range.

For optimal performance, we recommend the use of a 3.0Ah battery or higher to operate this Power X Change Angle Grinder.

ONLINE MANUAL

Scan this QR Code with your mobile device to take you to the online manual.



SETUP & PREPARATION

1. ASSEMBLY



WARNING! ENSURE THE TOOL IS SWITCHED OFF AND THE BATTERY IS REMOVED BEFORE PERFORMING ANY OF THE FOLLOWING TASKS.

Fitting and Removing the Side Handle

- 1 To fit, screw the side handle clockwise into 1 of 3 handle positions.
- 2 To remove, screw the handle anti-clockwise.

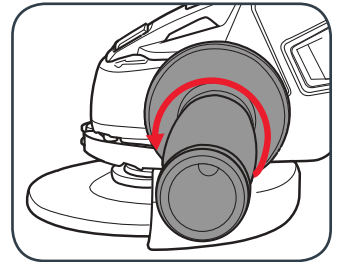
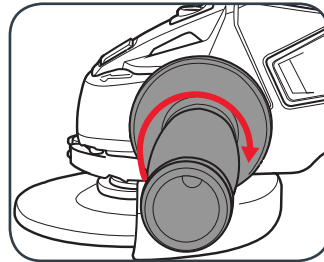

Safety Guard

The safety guard is pre-fitted to the angle grinder ready for use. The position of the guard can be adjusted following the steps below using a hex key (not supplied).

- 1 Loosen the safety guard locking screw to allow the guard to spin.
- 2 Rotate the guard into the desired position.

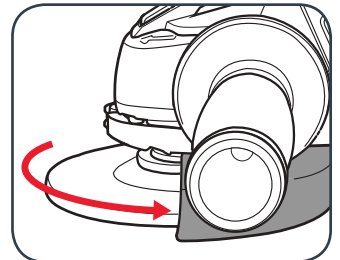
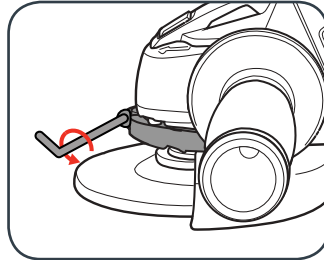

- 3 Tighten the safety guard locking screw to secure in position.

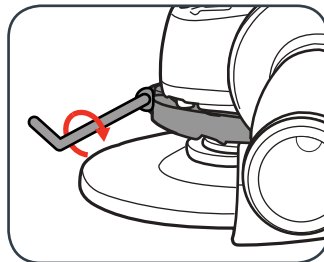

WARNING! DO NOT OPERATE THE ANGLE GRINDER WITHOUT THE SAFETY GUARD FITTED AS POSSIBLE INJURIES COULD OCCUR.

5 YEAR
REPLACEMENT WARRANTY

Inserting & Removing the Battery

- 1 Align the ribs of the battery with the recess at the back of the angle grinder & push in until it clicks into place.

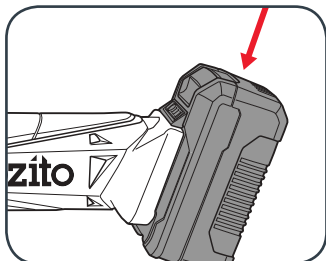

- 2 To remove, press and hold the battery release tab and then slide out.

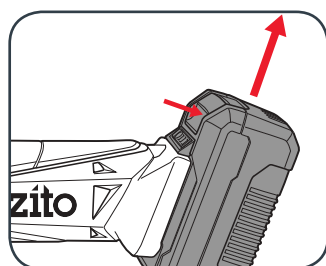

2. REPLACING A GRINDING DISC

- 1 Depress and hold the spindle lock to prevent the spindle spinning.

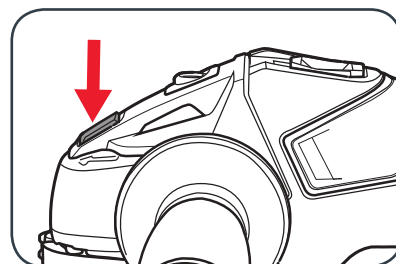

- 2 Using the pin wrench loosen the flange by rotating it anti-clockwise.

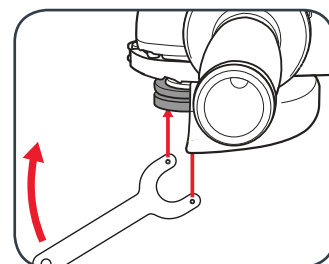

- 3 Remove the flange and replace the grinding disc on the spindle.

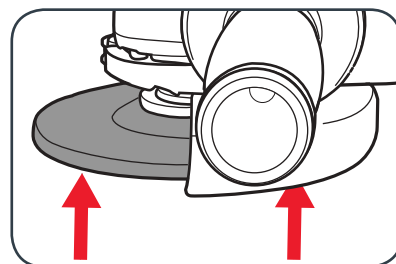

- 4 Screw the flange back onto the spindle and tighten using the pin wrench while holding the spindle lock down.

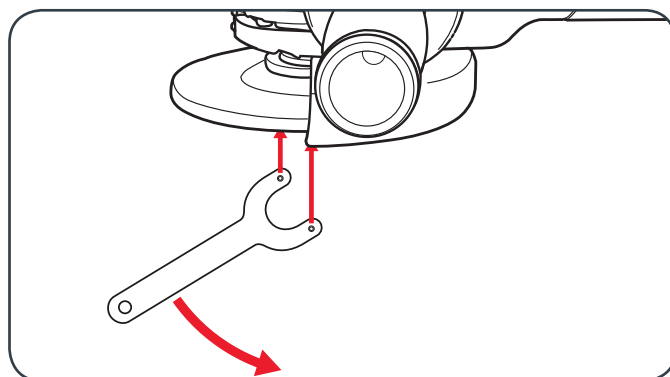

OPERATION

3. TURNING ON AND OFF

Turning On and Off

- 1 To turn on, slide the lock-on switch across to the right and then forward.

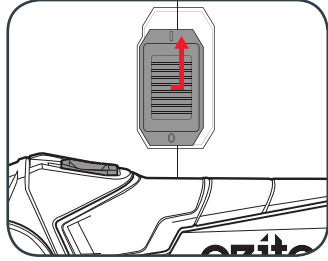

- 2 To turn off, slide the lock-on switch back and to the left.

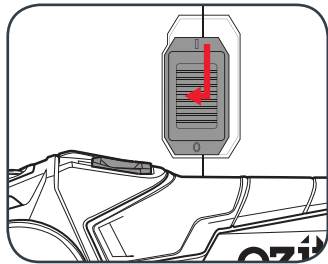

4. GRINDING

Grinding Procedure

- 1 Ensure the workpiece is securely held down.

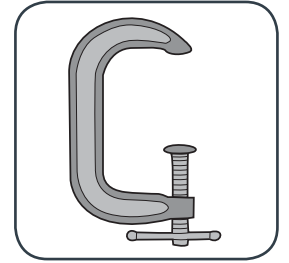

- 2 Hold the angle grinder firmly with both handles and switch on.

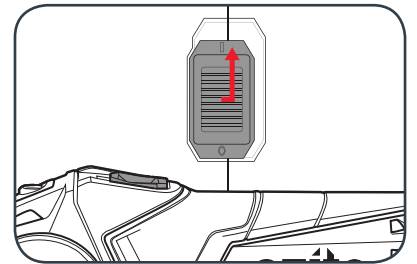

- 3 Begin grinding your workpiece. The optimum grinding angle is 10-15° to the workpiece.

Note: Do not apply excessive pressure. Allow the tool to do the work, this will prevent deep gouging.

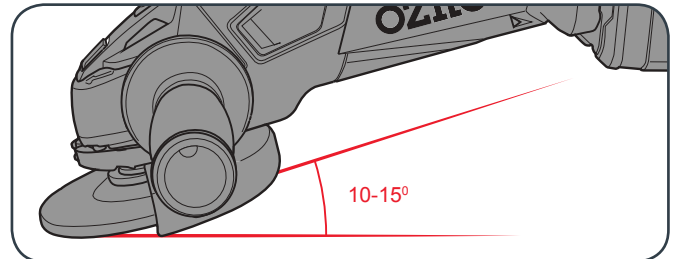

TROUBLESHOOTING

LED lights do not illuminate on charger

Check the charging adaptor is securely plugged into the wall outlet.
Check the battery is firmly connected to the charging cradle.
Check that the charging jack is securely connected to the charging cradle.

The battery has a short run time

Ensure the battery is properly charged. It will take 4-5 charging cycles before the battery reaches optimum charge and run time. On the initial charge, the battery requires 5 hours of charging. Subsequent charging only requires 3-5 hours.

Sparking visible through the housing vents

A small amount of sparking may be visible through the housing vents.
This is normal and does not indicate a problem.

Spindle locking button will not depress

The spindle will need to be rotated until the lock can engage. Simply rotate the spindle while applying a small amount of pressure on the spindle lock.

MAINTENANCE



WARNING! ALWAYS ENSURE THE TOOL HAS COMPLETELY STOPPED AND THE BATTERY IS REMOVED PRIOR TO ANY MAINTENANCE.

- After each use, blow air through the tool housing to ensure it is free from all dust, dirt, etc. Build up of dust, dirt particles may cause the tool to overheat and shorten the life of the tool.
- If the housing of the angle grinder requires cleaning, do not use solvents but a moist soft cloth or soft brush only.
- Never let any liquid get inside the tool, never immerse any part of the tool into liquid.
- When not in use, the angle grinder should be stored in a dry, frost free location not within the reach of children.

Note: Ozito Industries will not be responsible for any damage or injuries caused by the repair of the angle grinder by an unauthorised person or by mishandling of the angle grinder.

SPARE PARTS

Spare parts can be ordered from the Special Orders Desk at your local Bunnings Warehouse.

For further information, or any parts not listed here, visit www.ozito.com.au or contact Ozito Customer Service:

Australia 1800 069 486

New Zealand 0508 069 486

E-mail: enquiries@ozito.com.au

DESCRIPTION OF SYMBOLS

V	Volts	Hz	Hertz
ac/~	Alternating current	Ah	Amp hour
dc/---	Direct current	n₀	No load speed
/min	Revolutions or reciprocation per minute	mA	Milliamperes
	Regulatory Compliance Mark (RCM)		Warning
	Read instruction manual		Always wear gloves
	Wear eye protection		Always wear ear, eye and a safety mask

CARING FOR THE ENVIRONMENT



Power tools that are no longer usable should not be disposed of with household waste but in an environmentally friendly way. Please recycle where facilities exist. Check with your local council authority for recycling advice.



Recycling packaging reduces the need for landfill and raw materials. Reuse of recycled material decreases pollution in the environment. Please recycle packaging where facilities exist. Check with your local council authority for recycling advice.



ELECTRICAL SAFETY



WARNING! When using mains-powered tools, basic safety precautions, including the following, should always be followed to reduce risk of fire, electric shock, personal injury and material damage.

Read the whole manual carefully and make sure you know how to switch the tool off in an emergency, before operating the tool.

Save these instructions and other documents supplied with this tool for future reference.

The charger has been designed for 230V and 240V only. Always check that the power supply corresponds to the voltage on the rating plate.

Note: The supply of 230V and 240V on Ozito tools are interchangeable for Australia and New Zealand.



This tool's charger is double insulated therefore no earth wire is required.

If the supply cord is damaged, it must be replaced by an electrician or a power tool repairer in order to avoid a hazard.

Note: Double insulation does not take the place of normal safety precautions when operating this tool. The insulation system is for added protection against injury resulting from a possible electrical insulation failure within the tool.

The power supply for this product's charger should be protected by a residual current device (rated at 30mA or less). A residual current device reduces the risk of electric shock.



GENERAL POWER TOOL SAFETY WARNINGS



WARNING! Read all safety warnings and all instructions. Failure to follow the warnings and instructions may result in electric shock, fire and/or serious injury.

Save all warnings and instructions for future reference. The term "power tool" in the warnings refers to your mains-operated (corded) power tool or battery-operated (cordless) power tool.

1. Work area safety

- Keep work area clean and well lit.** Cluttered or dark areas invite accidents.
 - Do not operate power tools in explosive atmospheres, such as in the presence of flammable liquids, gases or dust.** Power tools create sparks which may ignite the dust or fumes.
 - Keep children and bystanders away while operating a power tool.** Distractions can cause you to lose control.
- ## 2. Electrical safety
- Power tool plugs must match the outlet. Never modify the plug in any way. Do not use any adapter plugs with earthed (grounded) power tools.** Unmodified plugs and matching outlets will reduce risk of electric shock.
 - Avoid body contact with earthed or grounded surfaces, such as pipes, radiators, ranges and refrigerators.** There is an increased risk of electric shock if your body is earthed or grounded.
 - Do not expose power tools to rain or wet conditions.** Water entering a power tool will increase the risk of electric shock.
 - Do not abuse the cord. Never use the cord for carrying, pulling or unplugging the power tool. Keep cord away from heat, oil, sharp edges or moving parts.** Damaged or entangled cords increase the risk of electric shock.
 - When operating a power tool outdoors, use an extension cord suitable for outdoor use.** Use of a cord suitable for outdoor use reduces the risk of electric shock.
 - If operating a power tool in a damp location is unavoidable, use a residual current device (RCD) protected supply.** Use of an RCD reduces the risk of electric shock.

3. Personal safety

- Stay alert, watch what you are doing and use common sense when operating a power tool. Do not use a power tool while you are tired or under the influence of drugs, alcohol or medication.** A moment of inattention while operating power tools may result in serious personal injury.
- Use personal protective equipment. Always wear eye protection.** Protective equipment such as dust mask, non-skid safety shoes, hard hat, or hearing protection used for appropriate conditions will reduce personal injuries.
- Prevent unintentional starting. Ensure the switch is in the off-position before connecting to power source and/or battery pack, picking up or carrying the tool. Carrying power tools with your finger on the switch or energising power tools that have the switch on invites accidents.**
- Remove any adjusting key or wrench before turning the power tool on.** A wrench or a key left attached to a rotating part of the power tool may result in personal injury.
- Do not overreach. Keep proper footing and balance at all times.** This enables better control of the power tool in unexpected situations.

- Dress properly. Do not wear loose clothing or jewellery. Keep your hair, clothing and gloves away from moving parts.** Loose clothes, jewellery or long hair can be caught in moving parts.
- If devices are provided for the connection of dust extraction and collection facilities, ensure these are connected and properly used.** Use of dust collection can reduce dust-related hazards.

4. Power tool use and care

- Do not force the power tool. Use the correct power tool for your application.** The correct power tool will do the job better and safer at the rate for which it was designed.
- Do not use the power tool if the switch does not turn it on and off.** Any power tool that cannot be controlled with the switch is dangerous and must be repaired.
- Disconnect the plug from the power source and/or the battery pack from the power tool before making any adjustments, changing accessories, or storing power tools.** Such preventive safety measures reduce the risk of starting the power tool accidentally.
- Store idle power tools out of the reach of children and do not allow persons unfamiliar with the power tool or these instructions to operate the power tool.** Power tools are dangerous in the hands of untrained users.
- Maintain power tools. Check for misalignment or binding of moving parts, breakage of parts and any other condition that may affect the power tool's operation. If damaged, have the power tool repaired before use.** Many accidents are caused by poorly maintained power tools.
- Keep cutting tools sharp and clean.** Properly maintained cutting tools with sharp cutting edges are less likely to bind and are easier to control.
- Use the power tool, accessories and tool bits etc. in accordance with these instructions, taking into account the working conditions and the work to be performed.** Use of the power tool for operations different from those intended could result in a hazardous situation.

5. Battery tool use and care

- Recharge only with the charger specified by the manufacturer.** A charger that is suitable for one type of battery pack may create a risk of fire when used with another battery pack.
- Use power tools only with specifically designated battery packs.** Use of any other battery packs may create a risk of injury and fire.
- When battery pack is not in use, keep it away from other metal objects, like paper clips, coins, keys, nails, screws or other small metal objects, that can make a connection from one terminal to another.** Shorting the battery terminals together may cause burns or a fire.
- Under abusive conditions, liquid may be ejected from the battery; avoid contact. If contact accidentally occurs, flush with water. If liquid contacts eyes, additionally seek medical help.** Liquid ejected from the battery may cause irritation or burns.

6. Service

- Have your power tool serviced by a qualified repair person using only identical replacement parts.** This will ensure that the safety of the power tool is maintained.



ANGLE GRINDER SAFETY WARNINGS



WARNING! a) This power tool is intended to function as a grinder, sanding or cut-off tool. Read all safety warnings, instructions, illustrations and specifications provided with this power tool.

Failure to follow all instructions listed below may result in electric shock, fire and/or serious injury.

- Operations such as wire brushing, or polishing are not recommended to be performed with this power tool.** Operations for which the power tool was not designed may create a hazard and cause personal injury.
- Do not use accessories which are not specifically designed and recommended by the tool manufacturer.** Just because the accessory can be attached to your power tool, it does not assure safe operation.
- The rated speed of the accessory must be at least equal to the maximum speed marked on the power tool.** Accessories running faster than their rated speed can break and fly apart.
- The outside diameter and the thickness of your accessory must be within the capacity rating of your power tool.** Incorrectly sized accessories cannot be adequately guarded or controlled.
- The arbour size of wheels, flanges, backing pads or any other accessory must properly fit the spindle of the power tool.** Accessories with arbour holes that do not match the mounting hardware of the power tool will run out of balance, vibrate excessively and may cause loss of control.
- Do not use a damaged accessory.** Before each use inspect the accessory such as abrasive wheels for chips and cracks, backing pad for cracks, tear or excess wear, wire brush for loose or cracked wires. If power tool or accessory is dropped, inspect for damage or install an undamaged accessory. After inspecting and installing an accessory, position yourself and bystanders away from the plane of the rotating accessory and run the power tool at maximum no-load speed for one minute. Damaged accessories will normally break apart during this test time.
- Wear personal protective equipment.** Depending on application, use face shield, safety goggles or safety glasses. As appropriate, wear dust mask, hearing protectors, gloves and workshop apron capable of stopping small abrasive or work piece fragments. The eye protection must be capable of stopping flying debris generated by various operations. The dust mask or respirator must be capable of filtering particles generated by your operation. Prolonged exposure to high intensity noise may cause hearing loss.
- Keep bystanders a safe distance away from work area.** Anyone entering the work area must wear personal protective equipment. Fragments away and cause injury beyond immediate area of operation.
- Hold power tool by insulated gripping surfaces only, when performing an operation where the cutting accessory may contact hidden wiring or its own cord.** Cutting accessory contacting a "live" wire may make exposed metal parts of the power tool "live" and shock the operator.
- Never lay the power tool down until the accessory has come to a complete stop.** The spinning accessory may grab the surface and pull the power tool out of your control.
- Do not run the power tool while carrying it at your side.** Accidental contact with the spinning accessory could snag your clothing, pulling the accessory into your body.
- Regularly clean the power tool's air vents.** The motor's fan will draw the dust inside the housing and excessive accumulation of powdered metal may cause electrical hazards.
- Do not operate the power tool near flammable materials.** Sparks could ignite these materials.
- Do not use accessories that require liquid coolants.** Using water or other liquid coolants may result in electrocution or shock.

Kickback and related warnings

Kickback is a sudden reaction to a pinched or snagged rotating wheel, backing pad, brush or any other accessory. Pinching or snagging causes rapid stalling of the rotating accessory which in turn causes the uncontrolled power tool to be forced in the direction opposite of the accessory's rotation at the point of the binding.

For example, if an abrasive wheel is snagged or pinched by the work piece, the edge of the wheel that is entering into the pinch point can dig into the surface of the material causing the wheel to climb out or kick out. The wheel may either jump toward or away from the operator, depending on direction of the wheel's movement at the point of pinching. Abrasive wheels may also break under these conditions. Kickback is the result of power tool misuse and/or incorrect operating procedures or conditions and can be avoided by taking proper precautions as given below.

a) **Maintain a firm grip on the power tool and position your body and arm to allow you to resist kickback forces.** Always use auxiliary handle, if provided, for maximum control over kickback or torque reaction during start-up. The operator can control torque reactions or kickback forces, if proper precautions are taken.

b) **Never place your hand near the rotating accessory.** Accessory may kickback over your hand.

c) **Do not position your body in the area where power tool will move if kickback occurs.** Kickback will propel the tool in direction opposite to the wheel's movement at the point of snagging.

d) **Use special care when working corners, sharp edges etc.** Avoid bouncing and snagging the accessory. Corners, sharp edges or bouncing have a tendency to snag the rotating accessory and cause loss of control or kickback.

e) **Do not attach a saw chain woodcarving blade or toothed saw blade.** Such blades create frequent kickback and loss of control.

Additional safety instructions for grinding and abrasive cutting-off operations

a) **Use only wheel types that are recommended for your power tool and the specific guard designed for the selected wheel.** Wheels for which the power tool was not designed cannot be adequately guarded and are unsafe.

b) **The guard must be securely attached to the power tool and positioned for maximum safety, so the least amount of wheel is exposed towards the operator.** The guard helps to protect operator from broken wheel fragments and accidental contact with wheel.

c) **Wheels must be used only for recommended applications.** For example: do not grind with the side of cut-off wheel. Abrasive cut-off wheels are intended for peripheral grinding, side forces applied to these wheels may cause them to shatter.

d) **Always use undamaged wheel flanges that are of correct size and shape for your selected wheel.** Proper wheel flanges support the wheel thus reducing the possibility of wheel breakage. Flanges for cut-off wheels may be different from grinding wheel flanges.

e) **Do not use worn down wheels from larger power tools.** Wheel intended for larger power tool is not suitable for the higher speed of a smaller tool and may burst.

Additional safety instructions for abrasive cutting-off operations:

a) **Do not "jam" the cut-off wheel or apply excessive pressure.** Do not attempt to make an excessive depth of cut. Overstressing the wheel increases the loading and susceptibility to twisting or binding of the wheel in the cut and the possibility of kickback or wheel breakage.

b) **Do not position your body in line with and behind the rotating wheel.** When the wheel, at the point of operation, is moving away from your body, the possible kickback may propel the spinning wheel and the power tool directly at you.

c) **When wheel is binding or when interrupting a cut for any reason, switch off the power tool and hold the power tool motionless until the wheel comes to a complete stop.** Never attempt to remove the cut-off wheel from the cut while the wheel is in motion otherwise kickback may occur. Investigate and take corrective action to eliminate the cause of wheel binding.

d) **Do not restart the cutting operation in the work piece.** Let the wheel reach full speed and carefully reenter the cut. The wheel may bind, walk up or kickback if the power tool is restarted in the work piece.

e) **Support panels or any oversized work piece to minimize the risk of wheel pinching and kickback.** Large work pieces tend to sag under their own weight. Supports must be placed under the work piece near the line of cut and near the edge of the work piece on both sides of the wheel.

f) **Use extra caution when making a "pocket cut" into existing walls or other blind areas.** The protruding wheel may cut gas or water pipes, electrical wiring or objects that can cause kickback.

Additional safety instructions for sanding operations

a) **Do not use excessively oversized sanding disc paper.** Follow manufacturers recommendations, when selecting sanding paper. Larger sanding paper extending beyond the sanding pad presents a laceration hazard and may cause snagging, tearing of the disc or kickback.

We highly recommend that when using abrasive cutting wheels, that a cutting guard should be fitted to your angle grinder. These cutting guards are available as a spare part and can be ordered through the special orders desk



18V LITHIUM ION

3.0Ah BATTERY

INSTRUCTION MANUAL

SPECIFICATIONS

Input:	18V
Battery Capacity:	3.0Ah Li-ion
Power Consumption:	54Wh
Weight:	0.60kg

ozito.com.au

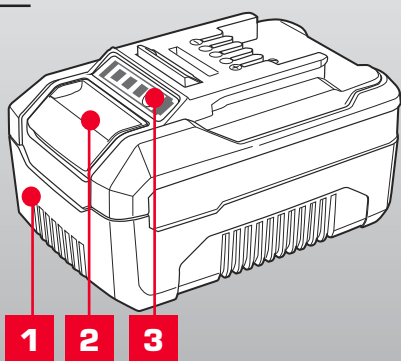

1. Battery
2. Battery Release Button
3. Charge Indicator Button

3 YEAR
REPLACEMENT WARRANTY

PXBP-300

DESCRIPTION OF SYMBOLS

V	Volts	Hz	Hertz
ac/~	Alternating Current	W	Watts
dc	Direct Current	Ah	Amp Hour
mA	Milliamperes		Warning
	Lithium Ion Battery		Do not store or use battery in temperatures exceeding 50°C
	Recycle Battery		Do not put in the rubbish
	Do not incinerate		Do not get battery wet
	Regulatory Compliance Mark (RCM)		Do not store battery when the charge is low; store between 40-60%.

CARING FOR THE ENVIRONMENT



Power tools that are no longer usable should not be disposed of with household waste but in an environmentally friendly way. Please recycle where facilities exist. Check with your local council authority for recycling advice.



Recycling packaging reduces the need for landfill and raw materials. Reuse of recycled material decreases pollution in the environment. Please recycle packaging where facilities exist. Check with your local council authority for recycling advice.

BATTERY SAFETY WARNINGS

THIS MANUAL CONTAINS IMPORTANT SAFETY AND OPERATING INSTRUCTIONS FOR YOUR BATTERY.

1. Before using the charger read all instructions and cautionary markings on the charger, battery pack and the product using the battery pack.
2. This charger is not intended for any uses other than charging Ozito Power X Change rechargeable batteries. Any other use may result in risk of fire, electric shock or electrocution.
3. Do not place any object on top of the charger or place the charger on a soft surface that may result in excessive internal heat. Place the charger in a position away from any heat source.
4. To reduce risk of damage to the electric plug and cord, pull by the plug rather than the cord when disconnecting the charger.
5. Make sure the cord is located so that it will not be stepped on, tripped over, or otherwise subjected to damage or stress.
6. An extension cord should not be used unless absolutely necessary. Use of an improper extension cord could result in the risk of fire, electric shock or electrocution.
7. Do not operate the charger if it has received a sharp blow, been dropped or otherwise damaged in any way. Have it checked by an electrician or power tool repairer.
8. Do not disassemble charger. Take it to an electrician or power tool repairer when service or repair is required. Incorrect reassembly may result in a risk of electric shock, electrocution or fire.
9. To reduce risk of electric shock, unplug the charger from the outlet before attempting any cleaning. Removing the battery pack will not reduce this risk.
10. Never attempt to connect 2 chargers together.
11. The charger is designed to operate on standard household electrical power (240 volts). Do not attempt to use it on any other voltage!
12. The battery pack is not fully charged out of the carton. First read the safety instructions and then follow the charging notes and procedures.
13. DO NOT STORE OR USE the battery pack in locations where the temperature may reach below 0°C or exceed 50°C (such as inside sheds or metal buildings in summer). This is important and will prevent damage to the battery pack.
14. Do not incinerate the battery pack even if it is seriously damaged or is completely worn out. The battery can explode in a fire.
15. Never attempt to open the battery pack for any reason. If the plastic housing of the battery pack breaks or cracks, immediately discontinue use and do not recharge.
16. During charging, the battery must be placed in a well ventilated area.

ELECTRICAL SAFETY

WARNING! When using mains-powered tools, basic safety precautions, including the following, should always be followed to reduce risk of fire, electric shock, personal injury and material damage.

Read the whole manual carefully and make sure you know how to switch the tool off in an emergency, before operating the tool.

Save these instructions and other documents supplied with this tool for future reference.

Note: The supply of 230V and 240V on Ozito tools are interchangeable for Australia and New Zealand.



This tool's charger is double insulated therefore no earth wire is required.

If the supply cord is damaged, it must be replaced by the manufacturer, its service agent or similarly qualified persons in order to avoid hazard.

Note: Double insulation does not take the place of normal safety precautions when operating this tool. The insulation system is for added protection against injury resulting from a possible electrical insulation failure within the tool.

Using an Extension Lead

Always use an approved extension lead suitable for the power input of this tool. Before use, inspect the extension lead for signs of damage, wear and ageing. Replace the extension lead if damaged or defective.

When using an extension lead on a reel, always unwind the lead completely. Use of an extension lead not suitable for the power input of the tool or which is damaged or defective may result in a risk of fire and electric shock.

To reduce the risk of electric shock, we recommend the use of a residual current device (rated 30mA or less).

This appliance is not intended for use by persons (including children) with reduced physical, sensory or mental capabilities, or lack of experience and knowledge, unless they have been given supervision or instruction concerning use of the appliance by a person responsible for their safety.

Children should be supervised to ensure that they do not play with the appliance.

1. OPERATION

Only use the battery pack with Ozito Power X Change 18V cordless products.

CHARGING YOUR LITHIUM ION BATTERY

This battery has been shipped in a low charge condition, and requires charging prior to use. Allow several cycles of charging and discharging (through use with a compatible tool) for the battery to reach its optimum performance / runtime.

This battery is compatible with chargers from the 18V Ozito Power X Change range available through your local Bunnings Warehouse. Product availability may differ.

1. Insert the power plug of the charger into the mains socket outlet. The green LED will begin to flash when properly connected to power supply.
2. Insert the battery pack into the battery charger .
3. Remove battery from the charger once fully charged. Disconnect the charger from the power supply.

Note: The battery pack can become a little warm during the charging. This is normal.

If the battery pack fails to charge, check:

- if there is voltage at the socket outlet
- that the battery and charger are properly connected.

If the battery pack still fails to charge, please contact our customer service center.

BATTERY CHARGE INDICATOR

The purchased battery is equipped with a battery charge indicator to show the state of the battery charge.

Press the charge indicator button and look to see which LED lights.

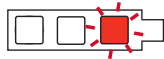
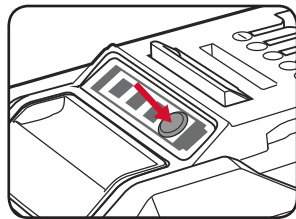

Battery requires immediate charging



Low state of charge, requires charging soon.

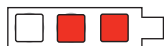

Mid state of charge



Full state of charge.

Note: The battery needs to be removed from the tool to check the state of charge.

BATTERY PROTECTION SYSTEM

The tool is equipped with a battery protection system, which helps to ensure longevity of the battery.

The output power automatically cuts off during operation when the tool and/or battery are placed under the following situations:

- When the tool is overloaded:
If this occurs, release the trigger switch and remove causes of overload, then pull the switch trigger again to restart.
- When the remaining battery capacity becomes low:
Recharge the battery pack.

Note: The battery protection system does not in any way damage the tool.

Note: The indicated capacity may be lower than the actual level during use or immediately after using the tool.

WARRANTY

IN ORDER TO MAKE A CLAIM UNDER THIS WARRANTY YOU MUST RETURN THE PRODUCT TO YOUR NEAREST BUNNINGS WAREHOUSE WITH YOUR BUNNINGS REGISTER RECEIPT. PRIOR TO RETURNING YOUR PRODUCT FOR WARRANTY PLEASE TELEPHONE OUR CUSTOMER SERVICE HELPLINE:

Australia 1800 069 486

New Zealand 0508 069 486

TO ENSURE A SPEEDY RESPONSE PLEASE HAVE THE MODEL NUMBER AND DATE OF PURCHASE AVAILABLE. A CUSTOMER SERVICE REPRESENTATIVE WILL TAKE YOUR CALL AND ANSWER ANY QUESTIONS YOU MAY HAVE RELATING TO THE WARRANTY POLICY OR PROCEDURE.

The benefits provided under this warranty are in addition to other rights and remedies which are available to you at law.

Our goods come with guarantees that cannot be excluded at law. You are entitled to a replacement or refund for a major failure and for compensation for any other reasonably foreseeable loss or damage. You are also entitled to have the goods repaired or replaced if the goods fail to be of acceptable quality and the failure does not amount to a major failure.

Generally you will be responsible for all costs associated with a claim under this warranty, however, where you have suffered any additional direct loss as a result of a defective product you may be able to claim such expenses by contacting our customer service helpline above.

36 MONTH REPLACEMENT WARRANTY

Your product is guaranteed for a period of **36 months from the original date of purchase** and is intended for DIY (Do It Yourself) use only. If a product is defective it will be replaced in accordance with the terms of this warranty. Warranty excludes consumable parts.

WARNING

The following actions will result in the warranty being void.

- If the tool has been operated on a supply voltage other than that specified on the tool.
- If the tool shows signs of damage or defects caused by or resulting from abuse, accidents or alterations.
- Failure to perform maintenance as set out within the instruction manual.
- If the tool is disassembled or tampered with in any way.

0219

ONLINE MANUAL

Scan this QR Code with your mobile device to take you to the online manual.



OZITO Australia/New Zealand (Head Office)
1-23 Letcon Drive, Bangholme, Victoria, Australia 3175.

PXBP-300



18V LITHIUM ION

FAST CHARGER

INSTRUCTION MANUAL

SPECIFICATIONS

Input:	200-250V ~AC 50-60Hz
Output:	21V DC, 3A
Battery Charge Time:	30Min - PXBP-150 (18V 1.5Ah)
	40Min - PXBP-200 (18V 2.0Ah)
	60Min - PXBP-300 (18V 3.0Ah)
	75Min - PXBP-400 (18V 4.0Ah)
	120Min - PXBP-520 (18V 5.2Ah)
	100Min - PXUBP-520 (18V 5.2Ah Ultra)

ozito.com.au

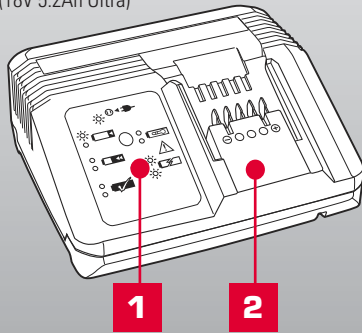

1. Charging Unit
2. Charging Unit LED

3 YEAR
REPLACEMENT WARRANTY

PXCG-030

DESCRIPTION OF SYMBOLS

V	Volts	Hz	Hertz
A	Amperes	Ah	Amp Hour
	Read Instruction Manual		Double Insulated
	Indoor Use Only		Do not dispose of in rubbish
	Do not charge battery in temperatures exceeding 40°C		Regulatory Compliance Mark (RCM)
	3.15A Slow Blow Fuse		Warning

CARING FOR THE ENVIRONMENT



Power tools that are no longer usable should not be disposed of with household waste but in an environmentally friendly way. Please recycle where facilities exist. Check with your local council authority for recycling advice.



Recycling packaging reduces the need for landfill and raw materials. Reuse of recycled material decreases pollution in the environment. Please recycle packaging where facilities exist. Check with your local council authority for recycling advice.

⚠ CHARGER SAFETY WARNINGS

THIS MANUAL CONTAINS IMPORTANT SAFETY AND OPERATING INSTRUCTIONS FOR YOUR CHARGER.

1. Before using the charger read all instructions and cautionary markings on the charger, battery pack and the product using the battery pack.
2. This charger is not intended for any uses other than charging Ozito Power X Change rechargeable batteries. Any other use may result in risk of fire, electric shock or electrocution.
3. Do not place any object on top of the charger or place the charger on a soft surface that may result in excessive internal heat. Place the charger in a position away from any heat source.
4. To reduce risk of damage to the electric plug and cord, pull by the plug rather than the cord when disconnecting the charger.
5. Make sure the cord is located so that it will not be stepped on, tripped over, or otherwise subjected to damage or stress.
6. An extension cord should not be used unless absolutely necessary. Use of an improper extension cord could result in the risk of fire, electric shock or electrocution.
7. Do not operate the charger if it has received a sharp blow, been dropped or otherwise damaged in any way. Have it checked by an electrician or power tool repairer.
8. Do not disassemble charger. Take it to an electrician or power tool repairer when service or repair is required. Incorrect reassembly may result in a risk of electric shock, electrocution or fire.
9. To reduce risk of electric shock, unplug the charger from the outlet before attempting any cleaning. Removing the battery pack will not reduce this risk.
10. Never attempt to connect 2 chargers together.
11. The charger is designed to operate on standard household electrical power (240 volts). Do not attempt to use it on any other voltage!
12. DO NOT USE the charger where the temperature may reach below 0° or exceed 40°C. If the battery pack is too hot or too cold charging will cease and begin automatically only when battery reaches correct charging temperature.
13. Do not incinerate the battery pack even if it is seriously damaged or is completely worn out. The battery can explode in a fire.
14. Never attempt to open the battery pack for any reason. If the plastic housing of the battery pack breaks or cracks, immediately discontinue use and do not recharge.
15. During charging, the battery must be placed in a well ventilated area.

⚠ ELECTRICAL SAFETY

⚠ WARNING! When using mains-powered tools, basic safety precautions, including the following, should always be followed to reduce risk of fire, electric shock, personal injury and material damage. Read the whole manual carefully and make sure you know how to switch the tool off in an emergency, before operating the tool. Save these instructions and other documents supplied with this tool for future reference.

Note: The supply of 230V and 240V on Ozito tools are interchangeable for Australia and New Zealand.



This tools charger is double insulated therefore no earth wire is required.

If the supply cord is damaged, it must be replaced by the manufacturer, its service agent or similarly qualified persons in order to avoid hazard.

Note: Double insulation does not take the place of normal safety precautions when operating this tool. The insulation system is for added protection against injury resulting from a possible electrical insulation failure within the tool.

Using an Extension Lead

Always use an approved extension lead suitable for the power input of this tool. Before use, inspect the extension lead for signs of damage, wear and ageing. Replace the extension lead if damaged or defective.

When using an extension lead on a reel, always unwind the lead completely. Use of an extension lead not suitable for the power input of the tool or which is damaged or defective may result in a risk of fire and electric shock.

To reduce the risk of electric shock, we recommend the use of a residual current device (rated 30mA or less).

This appliance is not intended for use by persons (including children) with reduced physical, sensory or mental capabilities, or lack of experience and knowledge, unless they have been given supervision or instruction concerning use of the appliance by a person responsible for their safety.

Children should be supervised to ensure that they do not play with the appliance.

ONLINE MANUAL

Scan this QR Code with your mobile device to take you to the online manual.



1. CHARGING A BATTERY



CAUTION: THE CHARGER SHOULD BE PROTECTED BY A RESIDUAL CURRENT DEVICE (RATED AT 30MA OR LESS).

1. Connect the charger to the power supply and the LED will flash green showing power is being supplied to the charger.

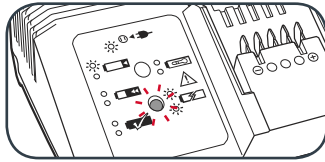

2. Align and then slide the ribs on the battery into the recess in the charger.

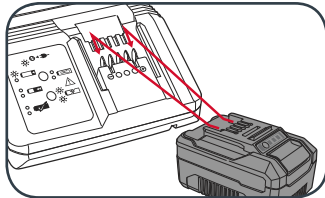

3. The red LED will illuminate while the battery charges.

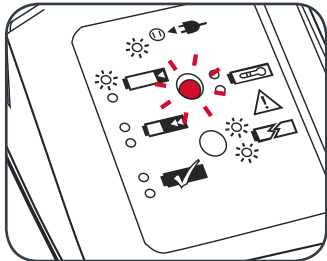

4. The green LED will illuminate once the battery is charged.

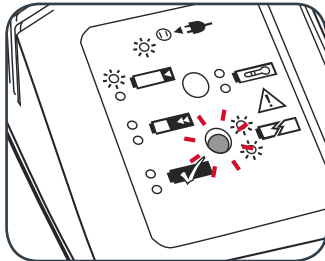

Charger LED Indicator Lights

LED Indicator	Situation
GREEN (Flashing)	Stand By (no battery pack is inserted)
RED (Flashing)	Battery is charging (low charge)
RED (Illuminated)	Battery is fast charging (mid charge)
GREEN (Illuminated)	Battery is 85% - 100% charged and is ready for use.
BOTH (Illuminated)	Battery pack is too hot or too cold (charging will begin automatically when battery reaches correct charging temperature).
BOTH (Flashing)	The battery is defective, charging is no longer possible. Do not charge. Contact Ozito Customer Service.

Mounting The Charging Unit On A Wall

The charging unit can be mounted to a wall or workbench. The correct dimensions for drill holes can be found on the back of the charging unit; a template for the mounting hole locations can also be found on the Ozito website.

Note: When mounting on a wall you must use suitable screws, e.g.M3 pan-head screws, in order to prevent damage to the housing and risk of falling.

2. MAINTENANCE

- Disconnect the charger from power source before cleaning.
- Keep the charger in a dry place out of reach of children.
- If the enclosure of the charger requires cleaning, do not use solvents. Use a dry, soft cloth only to wipe down the surface. Never let any liquid get inside the charger; never immerse any part of the charger.
- There are no other parts inside the charger which require maintenance. Do not take the charger apart. If the charger is damaged, contact your supplier or the manufacturer.

WARRANTY

IN ORDER TO MAKE A CLAIM UNDER THIS WARRANTY YOU MUST RETURN THE PRODUCT TO YOUR NEAREST BUNNINGS WAREHOUSE WITH YOUR BUNNINGS REGISTER RECEIPT. PRIOR TO RETURNING YOUR PRODUCT FOR WARRANTY PLEASE TELEPHONE OUR CUSTOMER SERVICE HELPLINE:

Australia 1800 069 486

New Zealand 0508 069 486

TO ENSURE A SPEEDY RESPONSE PLEASE HAVE THE MODEL NUMBER AND DATE OF PURCHASE AVAILABLE. A CUSTOMER SERVICE REPRESENTATIVE WILL TAKE YOUR CALL AND ANSWER ANY QUESTIONS YOU MAY HAVE RELATING TO THE WARRANTY POLICY OR PROCEDURE.

The benefits provided under this warranty are in addition to other rights and remedies which are available to you at law.

Our goods come with guarantees that cannot be excluded at law. You are entitled to a replacement or refund for a major failure and for compensation for any other reasonably foreseeable loss or damage. You are also entitled to have the goods repaired or replaced if the goods fail to be of acceptable quality and the failure does not amount to a major failure.

Generally you will be responsible for all costs associated with a claim under this warranty, however, where you have suffered any additional direct loss as a result of a defective product you may be able to claim such expenses by contacting our customer service helpline above.

36 MONTH REPLACEMENT WARRANTY

Your product is guaranteed for a period of **36 months from the original date of purchase** and is intended for DIY (Do It Yourself) use only. If a product is defective it will be replaced in accordance with the terms of this warranty. Warranty excludes consumable parts.

WARNING

The following actions will result in the warranty being void.

- If the tool has been operated on a supply voltage other than that specified on the tool.
- If the tool shows signs of damage or defects caused by or resulting from abuse, accidents or alterations.
- Failure to perform maintenance as set out within the instruction manual.
- If the tool is disassembled or tampered with in any way.