



**SPECIAL
ORDERS**



**WE WILL
DELIVER**



2018 RANGE & ACCESSORIES BROCHURE



Take This Brochure to the Special Orders Desk to place an order



Heat & Cook (Item no: 3170754)



As nature's original heat source and the world's first oven, fire still has the power to stir our most primal instincts, bringing people together to relax, engage and share our most intimate moments.

At Scandia, we know how to tame fire and we are experts in designing wood fires and stoves that thrive in the harshest of conditions. Our world class designs and commitment to quality are inspired by Scandinavian cultural values and the craftsmanship for which they are renowned. These same values resonate throughout our organisation, instilling a passion for designing great quality, affordable wood fires.

In the harsh winters of Scandinavia, fire is essential for survival and this is also true for many communities who rely on fire as the primary source of heating.

Fire is also about socialising, about bringing the outdoors in and allowing us to get back to nature. It keeps the gathering going outside as night falls when the chill in the air would send us back indoors.

At Scandia, we believe in the power of fire to bring people together. We believe in the power of Scandia to bring quality design and families together.



PRECISION ENGINEERING

Scandia utilises CNC laser technology and robotics to manufacture products of impeccable quality, engineered to precise specification.

TRADITIONAL RANGE





With origins forged in Australia and evolved for the New Zealand conditions, the classical styling and design of our traditional range represents the pinnacle in affordable, high quality wood heating.

Scandia wood fired appliances have many uses and attributes but there are a few things they all share:

- 10 year firebox warranty
- Crafted Japanese fireproof glass
- Firebrick lined fireboxes
- "Clearview" glass air wash system
- Quality European high temperature stove paint

HEAT & COOK

Whether it's wood fired pizza on the deck or the primary source of heating, cooking or hot water, this wood fired oven is as diverse as it is functional. Featuring cast iron doors and an extra large cooktop, the Heat & Cook is the perfect addition to any indoor or outdoor living space.

-  Heat up to 200m²
-  Large baker's oven
-  Optional hot water jacket
-  650w x 565d x 865h



Item no: 3170754

Heat & Cook is exempt from testing under AS/NZS 4012 and 4013







Item no: 0013836

NES, ECAN andty ORC Airshed 1 clean air approved

WARMBRITE 140LE

Perfect for the cottage home, holiday house or man cave, the Warmbrite 140LE is an affordable, radiant wood fire. The radiant construction method also means that the top panel of the firebox operates as a highly effective cooktop for soups, stews and pot roasts.

-  Heat up to 140m²
-  17kW estimated max performance
-  5mm heavy duty firebox
-  500w x 450d x 735h

63%
Efficiency

1.5g/kg
Emissions







Item no: 0013837

NES, ECAN andty ORC Airshed 1 clean air approved

WARMBRITE 200LE

This traditionally styled, medium sized, low emission, convection wood fire can be operated with or without the fan accommodating a multitude uses.

Engineered to effectively heat small to medium sized homes the 200LE also features an 8mm multi level cooktop and warming platform. The perfect addition to any indoor or undercover outdoor living space.

-  Heat up to 200m²
-  22kW estimated max performance
-  3 speed fan
-  Removable ash pan
-  675w x 597d x 745h

65%
Efficiency

0.5g/kg
Emissions







Item no: 0013838

NES, ECAN andty ORC Airshed 1 clean air approved

STACKER 200LE

This is a modern and practical adaptation of our most popular wood fire, the 200LE, with the addition of a handy wood storage pedestal designed to keep firewood dry and conveniently located.

The 8mm cooktop and warming platform makes the Stacker 200LE perfect for indoor and undercover outdoor living spaces.





-  Heat up to 200m²
-  22kW estimated max performance
-  Large wood storage
-  3 speed fan
-  685w x 607d x 895h

65%
Efficiency

0.5g/kg
Emissions

WARMBRITE 300LE

This traditionally styled, large format, low emission, convection wood fire is fitted with a three speed fan and has been purposely designed to operate effectively with or without the fan in use. A powerhouse appliance that is capable of heating large homes and open plan spaces up to 350m²; the 300LE also features an 8mm multi level cooktop and warming platform.

-  Heat up to 350m²
-  26kW estimated max performance
-  3 speed fan
-  Removable ash pan
-  780w x 664d x 870h

66%
Efficiency

0.9g/kg
Emissions







Item no: 0013835

NES, ECAN andty ORC Airshed 1 clean air approved

STACKER 300LE

The Stacker 300LE combines a large wood storage pedestal with the body of our classical Warmbrite 300LE to create a practical and powerful wood fire combination perfect for large open plan spaces.

Featuring an 8mm cooktop and large warming platform the Stacker 300LE is also ideal for pubs, clubs and enclosed alfresco spaces.

-  Heat up to 350m²
-  26kW estimated max performance
-  Large wood storage
-  3 speed fan
-  790w x 674d x 930h

66%
Efficiency

0.9g/kg
Emissions



NES, ECAN and ORC Airshed 1 clean air approved

EDGE 50

Evolving from French provincial origins, the Edge's clean lines and delicate legs convey style and elegance or select the stacker option for a more traditional feel.. Expansive glass panels on three sides encase a radiant firebox, and the large top is great for cooking winter soups and stews.

-  Heat up to 200m²
-  19kW estimated max performance
-  Optional wood storage pedestal
-  Panoramic fire views with glass on three sides
-  620w x 480d x 775h

62%
Efficiency

1.3g/kg
Emissions



Edge 50 Stacker. Product Code: SPE50ST







NES, ECAN andty ORC Airshed 1 clean air approved

PELLET FIRE

VERDANT LE

Verdant LE utilises environmentally sustainable, carbon neutral bio mass pellet fuel to provide the warmth and ambience of a traditional wood fire; burning up to 30 hours without the need to cut, split and store firewood.

-  Renewable fuel source
-  19kW estimated max performance
-  Thermostatic control (7 day programming)
-  Very low emissions 0.8g/kg
-  510w x 440d x 960h

79%
Efficiency

0.8g/kg
Emissions



Item no: 3171530

NES, ECAN andty ORC Airshed 1 clean air approved

WOOD STORAGE

FIREWOOD STORAGE

The Scandia wood storage range represents quality, functionality and inspired design. This range of products has been developed with the same ethos we use when developing any product that we sell. It must be affordable, on the cutting edge of design, be robust and fit for purpose.

When it came to wood storage this simply meant that everything we produce has to look great, provide indoor and outdoor application and be strong enough to hold decent quantities of seasoned hardwood...We think we've nailed it.

BEEHIVE 500 WOOD STORAGE

Used individually or collectively, the 500mm black metallic beehive is ideal for indoor living spaces.

- Easy to assemble
- Stackable
- Powder coated finish
- Quality steel construction







Image depicted with 3 x Beehive 500 Metallic Black Wood Storage. Individual beehive units sold separately. Item: 3171648



750 Round Wood Storage. Item: 3171650. Removable stand for wall mount option

750 ROUND

Finished in metallic black powder coat this elegant yet practical wood storage solution can also be wall mounted to create a feature in any living space.

-  Holds up to 40kg of firewood
-  Wall mount option
-  3 Storage compartments
-  Removable base
-  750w x 350d x 750h



Curved Cantilever Wood Storage. Item: 3171652

CURVED CANTILEVER

The soft curves and stylish appearance mask the robust 6mm steel used in the construction of this quality accessory. With an emphasis on clean lines the cantilever design requires no tools or fixtures to assemble.

-  Holds up to 20kg of firewood
-  Powder coated
-  Easy to assemble
-  790w x 140d x 250h

FIRE TOOL RANGE

CLASSIC / DELUXE FIRE TOOL SET

The Classic & Deluxe fire tool sets by Scandia form part of our traditionally styled range of high quality accessories ideally suited to our range of classically styled wood fired appliances.

INCLUDES:

- Fireside brush
- Fireside shovel
- Fire poker
- Ash scraper
- Stand



Classic Firetool Set. Item no: 3180727



Deluxe Firetool Set. Item no: 3180728

HEARTHES



Item no: 3171524



CERAMIC TILE HEARTH – STRAIGHT INSTALL

This modern, black, ceramic tile hearth pad is made from durable, non-combustible materials, is easy to install and available in two sizes; suitable for all wood heater brands.

– Steel angle frame on all sides

1050 x 1200 Item no: 3171522

1050 x 1050 Item no: 3171524

-  Steel edged frame
-  High quality non-combustible construction
-  Contemporary design





Item no: 3171526

CERAMIC TILE HEARTH – CORNER INSTALL

This modern, black, ceramic tile hearth pad is made from durable, non-combustible materials, is easy to install; suitable for all wood heater brands.

– Steel angle frame on all sides

1250 x 1250 Item no: 3171526

-  Steel edged frame
-  High quality non-combustible construction
-  Contemporary design

INSTALLATION ACCESSORIES



BLACK MESH DEFAULT 4M FLUE KIT

Designed and tested to suit all Scandia freestanding wood fires, the powder coated, black mesh decorative flue looks great on any of the classically styled wood fire range.

- Triple skin flue
- 304 SST active flue
- 304 SST cowl and cone
- Powder coated ceiling collar
- Powder coated finish



Black Mesh Default Flue Kit. Item no: 3180672



1m Black mesh flue extension. Item no: 3170782



Black mesh rear bend kit. Item no: 3170794



1m External flue extension. Item no: 3170783



45° External bend kit. Item no: 3170799

BLACK MESH INTERNAL BEND KIT - 1M

Designed and tested to suit all Scandia freestanding wood fires, the powder coated, black mesh decorative flue extension looks great on any of the traditional wood fire range.

- Classic design
- 304 SST active flue
- Powder coated finish

BLACK MESH REAR BEND KIT

Designed as an easy add on to the Scandia 4m default flue kit (3180673), the powder coated, black mesh 45° bend kit directs the decorative flue toward the rear wall.

- Classic design
- Direction: Rear facing
- 304 SST active flue
- Powder coated finish

EXTERNAL FLUE EXTENSION - 1M

Designed as an easy add on to the Scandia 4m default flue kit (3180673), the external flue extension is meant for use outdoors or in a ceiling cavity.

- 6" Stainless steel flue
- 8" Galvanised steel flue
- 10" Galvanised steel flue

45° EXTERNAL BEND KIT

Designed as an easy add on to the Scandia 4m default flue kit (3180673), the external bend kit is meant for use outdoors or in a ceiling cavity.

- 6" Stainless steel 45° bend
- 8" Galvanised steel 45° bend
- 10" Galvanised steel 45° bend

MAINTENANCE & ACCESSORIES



Large child safety guard. Item no: 3180725

CHILD SAFETY GUARD

These sturdy child safety guards will minimise the risk of coming into contact with what can be extremely hot surfaces. Suits most wood fires.

- Heavy duty steel construction
- Rear stabilising bar
- Dual opening door
 - Large: 860w x 600h
 - Small: 685w x 600h
- Size (mm):
 - Large: 1275w x 1275d x 800h
 - Small: 1080w x 1055d x 800h



Small child safety guard. Item no: 3180726



6" Extendable Flue Brush. Item no: 3180729

6" EXTENDABLE FLUE BRUSH

Clean your flue safely from ground level up to 5m with the Scandia flexible flue brush kit. Pull through and rooftop cleaning options are also supported.

- Five 1m flexible extensions
- Premium 6" poly brush
- Threaded metal connectors
- Pull through option fitted

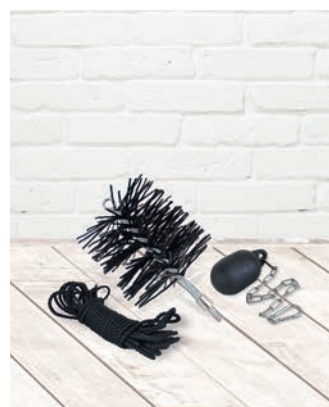

6" Pull thru flue brush kit. Item no: 3171521

6" PULL THRU FLUE BRUSH KIT

Simply attach the snap-lock weighted ball and chain and brush to each end of the rope provided for a pull thru flue cleaning solution.

- Weighted ball and chain
- 10m rope extension
- Snaplock connectors
- Heavy duty poly brush



Large child safety guard. Item no: 3180725

THERMAL POWERED ECO FAN

The Eco Fan can be positioned on the top panel of any radiant wood fire for the thermally powered motor to gently circulate warm air around any room.

- Ideal for use on all radiant wood fires and stoves
- Reduce your emissions by burning less fuel

ADDITIONAL INSTALLATION ITEMS

Additional parts required to complete your installation are available from Bunnings stores. Items not in stock can be ordered from the Special Orders desk – ask in store or visit the website for details.

Kits available:

- Roof Flashing
- Flexi Flue and Adapters
- Penetration and Drop Boxes

Additional accessories:

- Moisture Meter
- Rope Seals
- Cleaning products
- Firebricks
- Gasket & Adhesive sealant

TECHNICAL INFORMATION

PROFESSIONAL INSTALLATION

It is a requirement that all Scandia solid fuel and gas appliances are fitted by a qualified, licensed installer whose work complies with local council regulations, Local standards and manufacturer's specifications. Failure to correctly install is extremely dangerous, will void any warranty claims and may compromise any future insurance claims.

SCANDIA SOLID FUEL APPLIANCE COMPARISON CHART

	Firebox thickness	3 speed fan	Heating capacity	Emissions	Efficiency	Average kW Rating	Peak kW Rating	Net weight	Gross weight	Packaged (mm) W x D x H
WARMBRITE 140 LE	5mm	No	140m ²	0.7g/kg	67%	7.3kW	10.3kW	85kg	99kg	576 x 576 x 852
WARMBRITE 200 LE	6mm	Yes	200m ²	0.5g/kg	65%	7.0kW	9.9kW	175kg	195kg	770 x 687 x 890
STACKER 200 LE	6mm	Yes	200m ²	0.5g/kg	65%	7.0kW	9.9kW	184kg	204kg	770 x 687 x 1010
WARMBRITE 300 LE	6mm	Yes	350m ²	0.9g/kg	66%	8.6kW	13.5kW	219kg	239kg	871 x 768 x 1030
STACKER 300 LE	6mm	Yes	350m ²	0.9g/kg	66%	8.6kW	13.5kW	235kg	255kg	871 x 768 x 1090
HEAT & COOK	5.5mm	No	200m ²	NA	NA	-	-	229kg	246kg	770 x 710 x 1070
EDGE 50 LE	6mm	No	200m ²	1.0g/kg	66%	7.1kW	10.7kW	143kg	166kg	880 x 670 x 750
VERDANT LE	3mm	Variable	90m ²	0.8g/kg	79%	6.9kW	7.8kW	102kg	118kg	460 x 460 x 1150

CHOOSING THE RIGHT HEARTH PAD FOR YOUR HEATER..

	STRAIGHT WALL INSTALLATION		CORNER WALL INSTALL
	1050 x 1050	1050 x 1200	1200 x 1200
WARMBRITE 140LE	●		●
WARMBRITE 200LE & STACKER 200LE		●	●
WARMBRITE 300LE & STACKER 300LE		●	●
HEAT & COOK	●		●
EDGE 50LE	●		●
VERDANT LE	●		●

HEATER DIMENSIONS AND INSTALLATION CLEARANCES

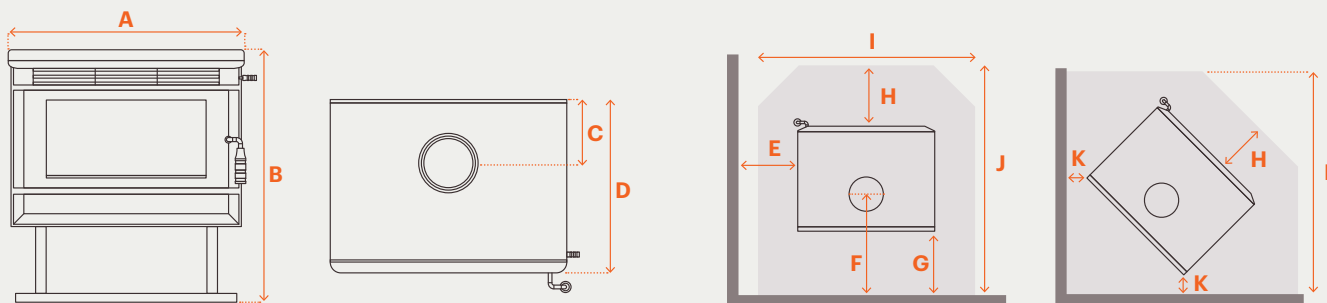

FREESTANDING HEATER DIMENSIONS

	UNIT SIZE (mm)						INTERNAL FIREBOX (mm)		
	A	B	C	D	FLUE Ø	WEIGHT	WIDTH	DEPTH	HEIGHT
WARMBRITE 140 LE	500	735	135	470	152	85kg	370	330	330
WARMBRITE 200 LE	645	725	160	565	152	175kg	450	345	345
STACKER 200 LE	665	845	170	575	152	184kg	450	345	345
WARMBRITE 300 LE	745	850	190	645	152	219kg	550	420	430
STACKER 300 LE	765	910	200	655	152	235kg	550	420	430
HEAT & COOK	650	860	120	610	152	229kg	430	330	-
OVEN SIZE							435	375	305
EDGE 50 LE	620	775	200	495	152	98kg	435	335	310
EDGE 50 WOODBOX	625	815	225	550	-		-	-	-
VERDANT LE	520	1020	-	500	80	102kg	200	150	500

*Dimensions listed are a guide only and are representative of the manufacturers specifications within an acceptable tolerance. All dimensions are taken from the widest part of the heater and exclude protrusions from the body of the appliance including handle, air slide and flue spigot. Refer to the installation manual for specific detail on the model you are installing.

FREESTANDING INSTALLATION CLEARANCES

	CLEARANCES TO COMBUSTIBLE SURFACES (mm)								
	E	F	G	H	I	J	K	L	
WARMBRITE 140 LE	650	360	225	300	750	1038	550	1396	
WARMBRITE 200 LE	300	335	175	400	900	960	100	1235	
STACKER 200 LE	300	335	175	400	900	960	100	1235	
WARMBRITE 300 LE	425	385	225	510	1000	1180	175	1518	
STACKER 300 LE	425	385	225	510	1000	1180	175	1518	
HEAT & COOK	425	294	175*	300	820	1084	200	1302	
EDGE 50 LE	650	303	150	300	835	1049	350	1352	
VERDANT LE	100	-	200**	300	635	730	25	-	

The above clearances are depicted as the worst case scenario when using either the Scandia default decorative mesh flue kit. (Decorative flue is fitted with an additional heat shield) or the Scandia default Sleek Black / Graphite flue kit. (Sleek black / Graphite flue is fitted with an additional heat shield)

**With vertical flue 200mm and horizontal flue 80mm.

Refer to the installation manual on our website for up to date / specific detail on the appliance you are installing.

PURCHASE CHECKLIST



STEP 1: CHOOSE YOUR WOOD FIRE

Select the style appliance with a heating capacity that best suits your home

FINELINE	WOOD FIRE	TICK
0013836	WARMBRITE 140 LE	
0013837	WARMBRITE 200 LE	
0013838	STACKER 200 LE	
0013835	WARMBRITE 300 LE	
	STACKER 300 LE	
	EDGE 50 LE	
	EDGE 50 WOOD BOX	



STEP 2: PURCHASE INSTALLATION ACCESSORIES

Always install an appliance with a matching flue kit and don't forget to purchase a roof flashing for your specific style of roofing. If you are installing on a combustible surface you will require a hearth.

FINELINE	REQUIRED ACCESSORIES	TICK
3180672	BLACK MESH DEFAULT FLUE KIT	
	ROOF FLASHING	

FINELINE	CERAMIC TILE HEARTH PAD	TICK
3171522	1050 x 1200 STRAIGHT WALL	
3171525	1200 x 1200 STRAIGHT WALL	
3171526	1250 x 1250 CORNER WALL	



STEP 3: ADDITIONAL INSTALLATION ACCESSORIES

Additional elements may be required for installations in homes with cathedral ceilings, a second storey or where the installation requires a through wall penetration.

FINELINE	REQUIRED ACCESSORIES	TICK
3170782	BLACK MESH FLUE EXTENSION	
3170798	BLACK MESH BEND KIT	
3170783	EXTERNAL FLUE EXTENSION	
3170799	EXTERNAL FLUE BEND KIT	
3170790	PENETRATION BOX	
	DROPBOX	
3171520	ANGLED CEILING COLLAR	
3180730	CEILING COLLAR	



STEP 4: CHOOSE YOUR WOOD FIRE ACCESSORIES

Scandia provide a complete range of tools and accessories to compliment and enhance your wood fired experience.

FINELINE	WOOD FIRE	TICK
3171648	BEEHIVE 500 WOOD STORAGE	
3171650	ROUND 750 WOOD STORAGE	
3171652	CURVED CANTILEVER WOOD STORAGE	
3180728	DELUXE FIRE TOOL SET	
3180727	CLASSIC FIRE TOOL SET	
3180726	SMALL HEATER GUARD	
3180725	LARGE HEATER GUARD	
3171516	ECO FAN	
3171513	MOISTURE METER	
3180729	6" FLEXIBLE FLUE BRUSH	
3171521	6" PULL THROUGH FLUE BRUSH	

CLEAR SKIES, CLEAR CONSCIENCE

When you purchase a Scandia wood fire, you can be confident in the knowledge that you are purchasing the only sustainable and most affordable renewable source of home heating available.

As a supporter and sponsor of Landcare, Scandia is mindful of any impact on the environment. Therefore, it's reassuring to us to know that 98 per cent of hardwood burnt is sustainably sourced, and by choosing to burn this firewood in a Scandia wood fire, you will generate no additional CO2 emissions than if that same wood were left to decompose naturally in the bush. (Kerryn Paul, 2003)

To control the amount of emissions released into the environment, Scandia designs all combustion wood fires with a two stage, primary and secondary air system. While the primary air controls the rate of burn, the secondary air system hyper-heats any excess carbon, converting the majority of residual emissions into energy which is then stored in the firebricks and firebox, improving overall efficiency of the heater and minimising any impact on the environment.

As an organisation, Scandia is committed to helping the environment through the promotion of renewable energy, sustainable harvesting practices and a commitment to programs that focus on reducing carbon emissions.

DISCLAIMER

Our philosophy of continuous improvement requires that information relating to our products and service are as accurate as possible at the time of printing. We do however reserve the right to make amendment and variations where deemed necessary. For the most current and up to date information we suggest downloading the latest owners manual from our website.

Scandia Heating (Aust) Pty Ltd has endeavoured to ensure that the information in this document is correct and fairly stated, but does not accept liability for any error or omission.

Scandia Heating (NZ) Ltd accepts no liability whatsoever for their interpretation of AS/NZS 2918-2001, AS/NZS 4012-4013. All heating capacities quoted are based on units tested with quality well seasoned firewood. Localised environmental factors may reduce the stated performance, this can occur when living spaces have large glassed areas, vaulted ceilings, draughts or insufficient insulation. Scandia reserves the right to alter specifications without notice.



Scandia Heating (Aust) Pty Ltd
58 Access way
Carrum Downs VIC 3201
Australia

00 61 3 8579 5902
service@scandiaheating.com.au
www.scandiaheating.com.au

