

ozito

12V SUBMERSIBLE WATER PUMP

6,750 L/H FLOW

INSTRUCTION MANUAL

SPECIFICATIONS

Voltage:	12V DC
Rated Input Power:	84 Watt
Current:	9Amp
Max. Flow Rate:	6,750 litres/hour
Max. Head:	5 meters
Size of Outlet:	Ø29mm
Power Cord:	5m
Weight:	1.4kgs

ozito.com.au

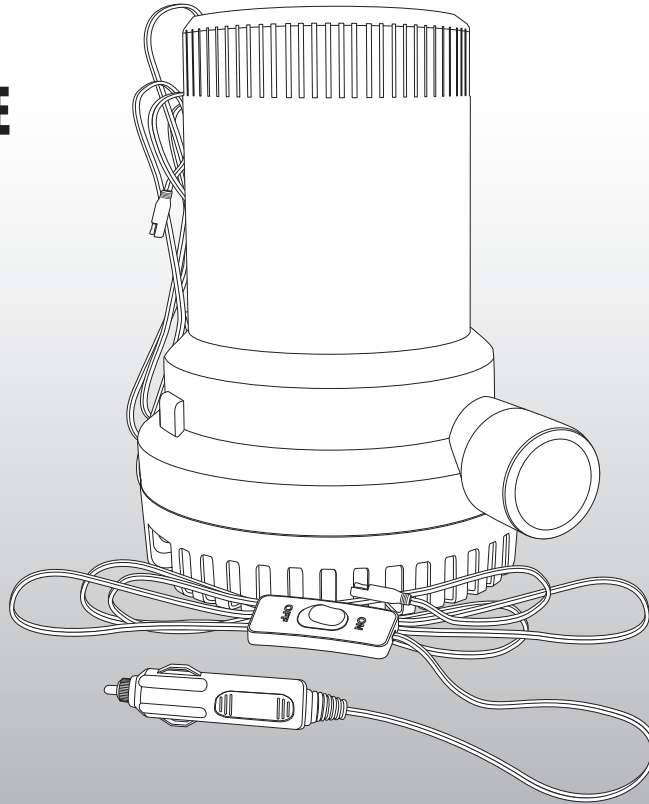

WHAT'S IN THE BOX

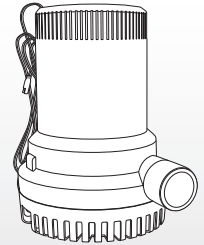

12V Submersible Pump

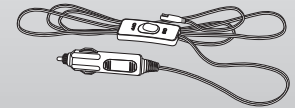

Auxiliary Cable - 2.1m
Cord with On/Off
Switch & 12V DC Plug

3 YEAR REPLACEMENT WARRANTY

SBP- 012

KNOW YOUR PRODUCT

SUBMERSIBLE PUMP

1. Pump Housing
2. Power Cord
3. Strainer Tabs
4. Discharge Outlet
5. Strainer

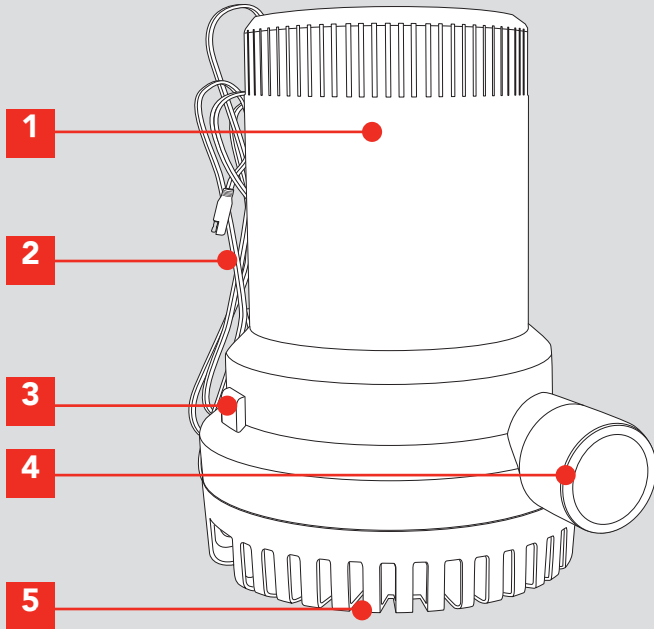

AUXILIARY CABLE

6. 12V DC Plug
7. On/Off Switch
8. Power Cord Connector

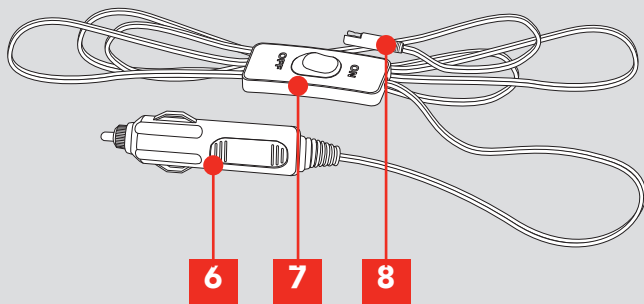

ONLINE MANUAL

Scan this QR Code with your mobile device to take you to the online manual.



SETUP & PREPARATION

1. INSTALLATION GUIDE

- Pump is suitable for use with fresh and salt water applications.
- The pump can be used for portable or permanent applications

Portable Applications

1. Prior to immersing the pump in water determine the depth of water for the length of hose required.

Note: Calculate overall hose length to pump to the desired location

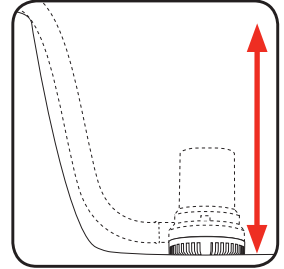

2. Attach a $\varnothing 29\text{mm}$ hose ($\varnothing 25\text{mm}$ min. hose recommended) (not supplied) to the discharge outlet and fasten with a stainless steel clamp (not supplied). It is recommended that you use a good quality hose that will not kink when making sharp bends.

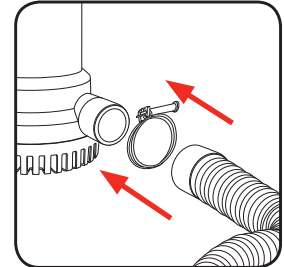

3. Determine the desired location for the pump. It is best located where the water is potentially deepest, i.e., at the lowest possible level of the area to be drained



4. Ensure that the hose is positioned in a way that runs level or continuously upward. This will eliminate the chance of air pockets developing.

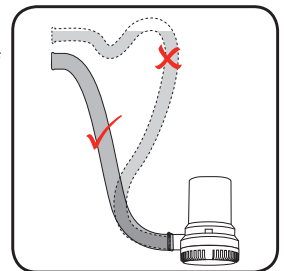

Note: Restricting the flow from the pump by using a smaller hose does not damage the pump however, it will reduce the flow.

3

YEAR REPLACEMENT WARRANTY

Permanent Applications

1. Determine the desired location and position for the pump. Refer "Portable Applications".

2. Remove the strainer from the bottom of the pump by depressing the strainer tabs, on both sides of the pump.

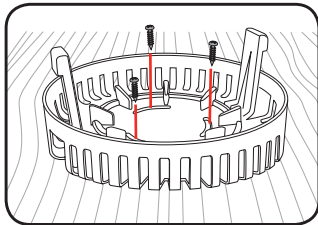
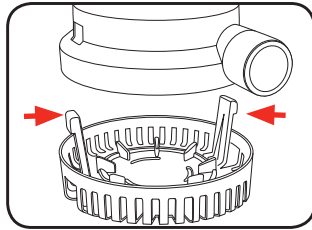

• If attaching the strainer to wood, fasten with stainless steel screws.

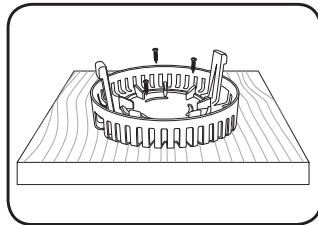

• If attaching the strainer to metal or fiberglass, first mount a wooden block to the surface, and then fasten the strainer to the wooden block.

3. Mount the pump on the strainer so that both lock tabs snap into place. (the pump may be reversed on these tabs if so desired).

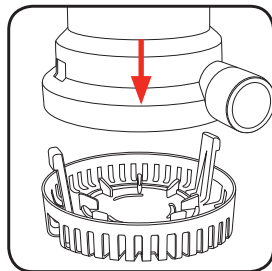

4. Attach hose. Refer "Portable Applications"

CAUTION: THE STRAINER MUST ALWAYS BE PROPERLY INSTALLED BEFORE ATTACHING AND RUNNING PUMP.

2. WIRING

Wiring

• The submersible pump comes supplied with an auxiliary cable. The 12V DC plug on the auxiliary cable enables the pump to be powered from a standard 12V power outlet found in cars, boats and some generators.

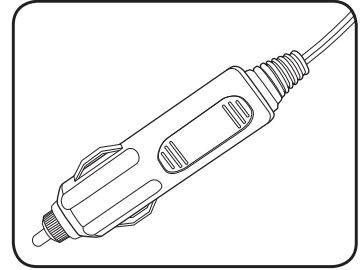

• The power cord of the submersible pump also comes with power cord connectors on both the pump cord and the auxiliary cable. This enables the wires to be connected quickly and accurately with less chance of a need for stripping or cutting.

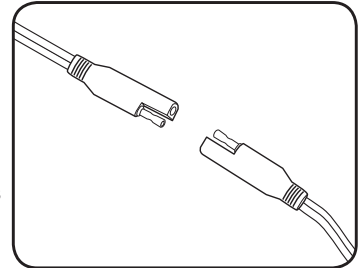

• The auxiliary cable has a ON/OFF switch which can be used to manually control the submersible pump.

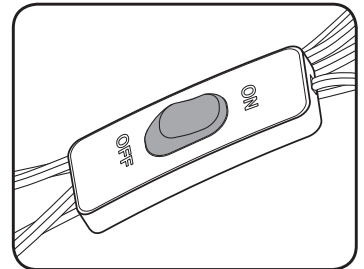

IMPORTANT!: ENSURE THAT ALL ELECTRICAL WIRING IS SECURED IN PLACE WITH THE CONNECTIONS WELL ABOVE THE POTENTIAL WATER LEVEL.

3. TROUBLE SHOOTING

The two wiring diagrams below show how to set up the submersible pump without a float switch (manual operation) and with a float switch (automatic operation).

Wiring for Manual Operation

The manual system is the simplest system but it only provides ON-OFF control of the pump. Consequently, pumps are often left ON longer than necessary.

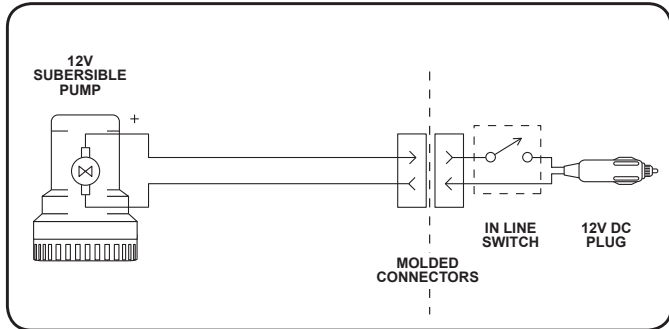

Wiring for Automatic Operation

For automatic operation, a float switch (available from specialized outlets) can be installed. A float switch detects the rising level of water and turns on the submersible pump. The pump then pumps the water out until its level has been substantially reduced, at which point the pump is switched off again. The automatic system assures that the area is always pumped out, even when unattended. It extends the life of the pump and your battery.

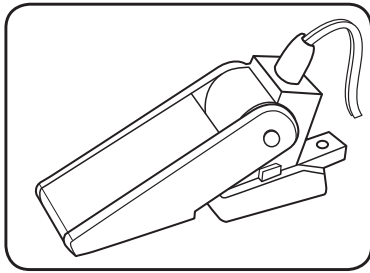

The automatic system also provides for manual control of the pump, as it includes an ON/OFF switch.

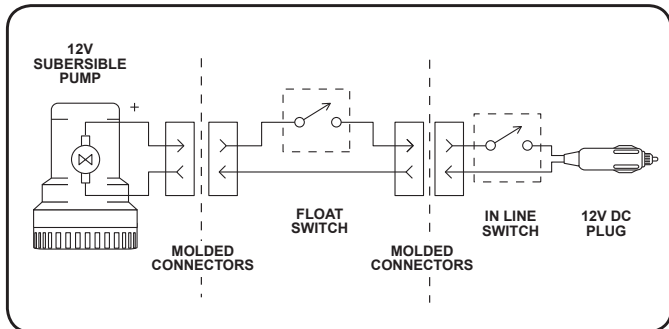

Note: When not using the supplied auxiliary cable (ie. when setting up a fixed installation), it is recommended that you use a 10 Amp fuse and a 12V/10 Amp power supply.

Symptom	Possible Cause	Cure
Pump not working	Blown fuse	Replace fuse in 12V DC Plug
Reduced Flow	Blocked strainer	Clean outside of strainer and clean debris from around impeller.
	Discharge line clogged	Clean out hose by back flushing.
	Low battery voltage	Check battery condition and charge if necessary.
	Kinked discharge hose	Change to a hose that does not kink at the bends.
No water pumped	Wire connections	Make sure wire connections are not corroded. Check to be sure no wire joins are hanging down into the water.
	Float switch failure. (if connected).	Lift end of float switch up - if pump runs, switch is OK. If pump does not run, turn manual switch to on position - if pump runs, automatic switch has failed.
Pump won't shut off.	Something under the float (if connected)	Clean under the float to make sure debris is not holding the float up.
	Stuck float (if connected).	Check to see that the float is loose moves freely. If float action appears sluggish and/or the float does not move freely, intermittent or sporadic operation of the pump may occur. This condition is usually the result of oil and/ or dirt accumulating in and around the movable parts of the switch. To correct, clean the switch, checking for smooth and free operation of the float. Repeat if necessary
	IMPORTANT. Switch mounted too low	If the pump is sucking air and the automatic switch has not reached the OFF position, then the switch may be mounted too low for the pump and should be reinstalled at least 6mm higher than the pump base.

MAINTENANCE

4. MAINTENANCE & STORAGE

Maintenance

Regularly check the pump to be sure that the filter base and impeller are not clogged with debris. To clean, push in the tabs and lift up the pump housing.



Note. The discharge hose need not be removed.

Storage

The pump itself is not affected by freezing temperatures . However, if the pump is embedded in ice or surrounded by ice, it cannot be used. Never turn the pump on if it is embedded in or surrounded by ice

IMPORTANT! BEFORE CLEANING YOUR SUBMERSIBLE PUMP OR CARRYING OUT ANY MAINTENANCE PROCEDURE, MAKE SURE THAT THE UNIT IS OFF AND THE PUMP IS DISCONNECTED FROM THE POWER SUPPLY TO PREVENT ACCIDENTAL STARTING.

DESCRIPTION OF SYMBOLS

V	Volts	W	Watts
DC	Direct current	mA	Milliamperes
L/H	Litres per hour	IP	Ingress protection from water
	Electrical Emissions Comfomity (EMC)	PVC	Polyvinyl chloride
	Warning		Read instruction manual

CARING FOR THE ENVIRONMENT



Pumps that are no longer usable should not be disposed of with household waste but in an environmentally friendly way. Please recycle where facilities exist. Check with your local council authority for recycling advice.



Recycling packaging reduces the need for landfill and raw materials. Reuse of recycled material decreases pollution in the environment. Please recycle packaging where facilities exist. Check with your local council authority for recycling advice.

SPARE PARTS

Strainer	SPSBP012-13
Auxiliary Cable	SPSBP012-14

Spare parts can be ordered from the Special Orders Desk at your local Bunnings Warehouse.

For further information, or any parts not listed here, visit www.ozito.com.au or contact Ozito Customer Service:

Australia 1800 069 486

New Zealand 0508 069 486

E-mail: enquires@ozito.com.au

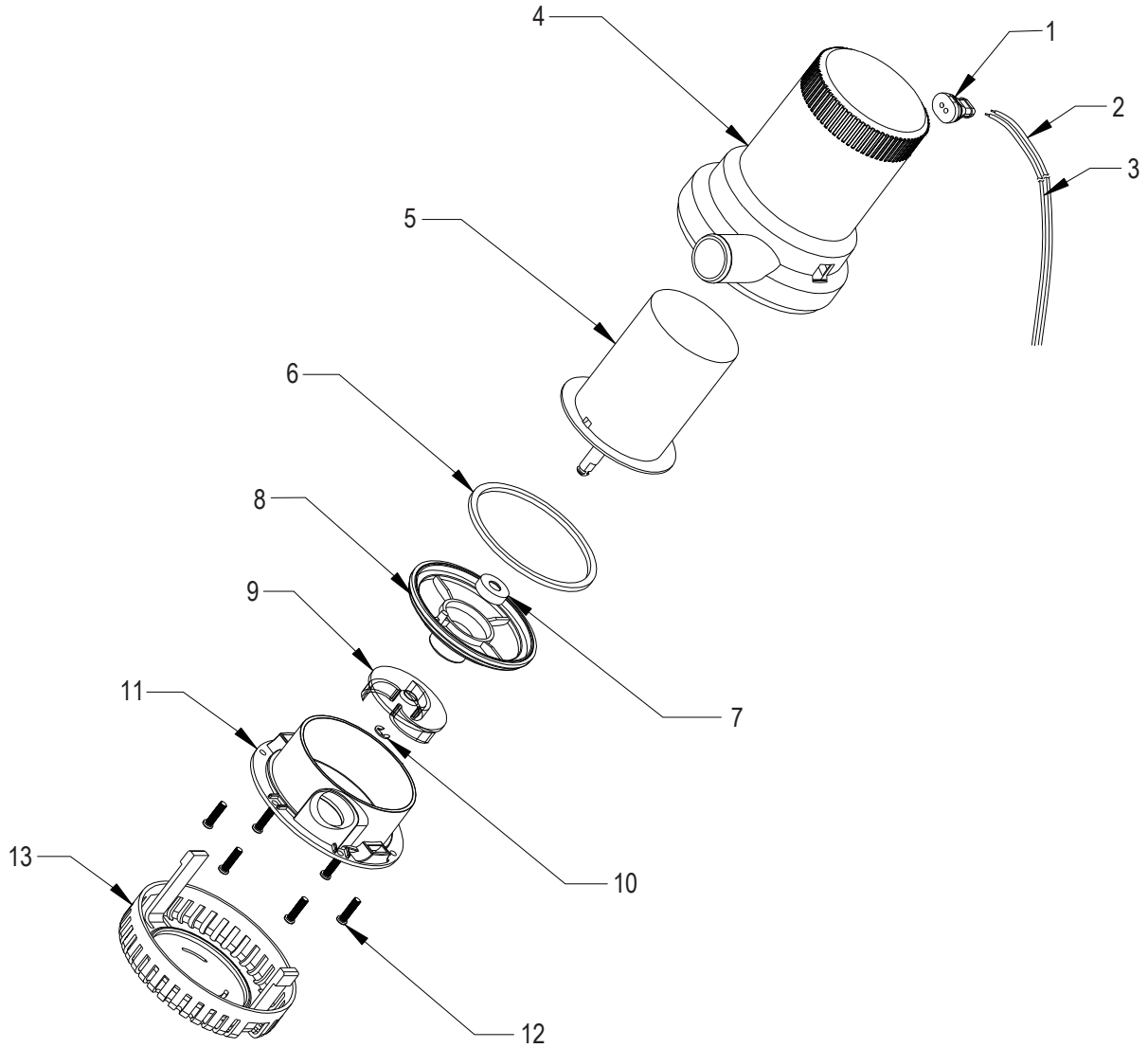

The following is a list of spare parts carried by Ozito.
Please contact Customer Service for any parts not listed.

Item No.	Description	Part No.	Item No.	Description	Part No.
13	Strainer	SPSBP012-13			
14	Auxiliary Cable	SPSBP012-14			

How To Order

Available spare parts can be ordered through the Special Orders Desk at any Bunnings Warehouse. If you have any further questions, please contact Ozito Customer Service on:

Australia: 1800 069 486

New Zealand: 0508 069 486

enquiries@ozito.com.au

GENERAL PUMP SAFETY WARNINGS

Read the whole manual carefully and make sure you know how to switch the tool off in an emergency, before operating the tool.

Save these instructions and other documents supplied with this tool for future reference.



WARNING! Read all safety warnings and all instructions. Failure to follow the warnings and instructions may result in electric shock, fire and/or serious injury.

Save these instructions

1. Work area

- Keep work area clean and well lit. Cluttered or dark areas invite accidents.
- Do not operate pumps in explosive atmospheres, such as in the presence of flammable liquids, gases or dust. Pumps create sparks which may ignite the dust or fumes.
- Keep children and bystanders away while operating a pump. Distractions can cause you to lose control.

2. Electrical safety

When using 12 Volt equipment, basic safety precautions, including the following, should always be followed to reduce risk of fire, electric shock, personal injury and material damage.

- Do not abuse the cord. Never use the cord for carrying, pulling or unplugging the pump. Keep cord away from heat, oil, sharp edges or moving parts. Damaged or entangled cords increase the risk of electric shock.
- The electric motor has been designed for 12V only. Always check that the power supply corresponds to the voltage on the rating plate.

3. Personal safety

- Stay alert, watch what you are doing and use common sense when operating a pump. Do not use a pump while you are tired or under the influence of drugs, alcohol or medication. A moment of inattention while operating pumps may result in serious personal injury.

- Avoid accidental starting. Ensure the switch is in the off position before plugging in. Carrying pumps with your finger on the switch or plugging in pumps that have the switch on invites accidents.
- Remove any adjusting key or wrench before turning the pump on. A wrench or a key left attached to a rotating part of the pump may result in personal injury.
- Dress properly. Do not wear loose clothing or jewellery. Keep your hair, clothing and gloves away from moving parts. Loose clothes, jewellery or long hair can be caught in moving parts.

4. Pump use and care

- Disconnect the plug from the power source before making any adjustments, changing accessories, or storing pumps. Such preventive safety measures reduce the risk of starting the pump accidentally.
- Maintain pumps. Check for misalignment or binding of moving parts, breakage of parts and any other condition that may affect the pumps operation. If damaged, have the pump repaired before use. Many accidents are caused by poorly maintained pumps.
- Use the pump, accessories and tool bits etc., in accordance with these instructions and in the manner intended for the particular type of pump, taking into account the working conditions and the work to be performed. Use of the pump for operations different from intended could result in a hazardous situation.

5. Service

- Have your pump serviced by a qualified repair person using only identical replacement parts. This will ensure that the safety of the pump is maintained.

SUBMERSIBLE PUMP SAFETY WARNINGS

CAUTION: Not intended for cleaning and other maintenance of swimming pools.



WARNING! This product is intended for pumping water in a home domestic application.

Do not use it for corrosive, abrasive, explosive or dangerous liquids. Fluids other than water will damage the submersible pump and/or create a fire hazard.



WARNING! This product is not suitable for use with drinking (potable) water.

This appliance is not intended for use by persons (including children) with reduced physical, sensory or mental capabilities, or lack of experience and knowledge, unless they have been given supervision or instruction concerning use of the appliance by a person responsible for their safety.

Children should be supervised to ensure that they don't play with the appliance.

- Ensure the submersible pump is disconnected from mains power when installing
- Do not install or operate the submersible pump in an explosive environment or near flammable material.
- Do not operate the submersible pump without liquid.
- Do not run the submersible pump dry.



WARNING! The submersible pump together with associated pipework operate under pressure.

Do not disconnect submersible pump or pipework until internal pressure has been released. Failure to do this could result in personal injury and damage to property.

- Avoid inserting hands into the inlets/outlets of the submersible pump while it is connected to mains power.
- Before using the submersible pump, always inspect it visually. Do not use the pump if it is cracked and/or damaged. If the submersible pump is damaged, contact customer service.

Never work or perform maintenance on the pump without first making sure it has been disconnected from the mains power.

Pollution of the liquid could occur due to leakage of lubricants.

IMPORTANT Avoid inserting hands into the mouth of the pump if it is connected to the mains. The electrical connections must always be made in a dry area. Make sure that electrical connections are protected from inundations. Protect the plug and the power cable from heat, oil or sharp edges. If damaged, the power cable must be replaced by a qualified electrician.

WARRANTY

IN ORDER TO MAKE A CLAIM UNDER THIS WARRANTY YOU MUST RETURN THE PRODUCT TO YOUR NEAREST BUNNINGS WAREHOUSE WITH YOUR BUNNINGS REGISTER RECEIPT. PRIOR TO RETURNING YOUR PRODUCT FOR WARRANTY PLEASE TELEPHONE OUR CUSTOMER SERVICE HELPLINE:

Australia 1800 069 486

New Zealand 0508 069 486

TO ENSURE A SPEEDY RESPONSE PLEASE HAVE THE MODEL NUMBER AND DATE OF PURCHASE AVAILABLE. A CUSTOMER SERVICE REPRESENTATIVE WILL TAKE YOUR CALL AND ANSWER ANY QUESTIONS YOU MAY HAVE RELATING TO THE WARRANTY POLICY OR PROCEDURE.

The benefits provided under this warranty are in addition to other rights and remedies which are available to you at law.

Our goods come with guarantees that cannot be excluded at law. You are entitled to a replacement or refund for a major failure and for compensation for any other reasonably foreseeable loss or damage. You are also entitled to have the goods repaired or replaced if the goods fail to be of acceptable quality and the failure does not amount to a major failure.

Generally you will be responsible for all costs associated with a claim under this warranty, however, where you have suffered any additional direct loss as a result of a defective product you may be able to claim such expenses by contacting our customer service helpline above.

3 YEAR REPLACEMENT WARRANTY

Your product is guaranteed for a period of **36 months from the original date of purchase**. If a product is defective it will be replaced in accordance with the terms of this warranty. Warranty excludes consumable parts, for example: o-rings, bearings, seals, gaskets, drain caps, and all accessories.

WARNING

The following actions will result in the warranty being void.

- If the pump has been operated on a supply voltage other than that specified on the tool.
- If the pump shows signs of damage or defects caused by or resulting from abuse, accidents or alterations.
- Failure to perform maintenance as set out within the instruction manual.
- If the pump is disassembled or tampered with in any way.
- Professional, industrial or high frequency use.