

# ozito

## BELT SANDER

**850W**

### INSTRUCTION MANUAL

#### SPECIFICATIONS

Input:	230-240V ~ 50Hz
Power:	850W
Belt Speed:	300-400m/min
Belt Surface:	75 x 140mm
Belt Size:	75 x 533mm
Weight:	3.1kg

[ozito.com.au](http://ozito.com.au)

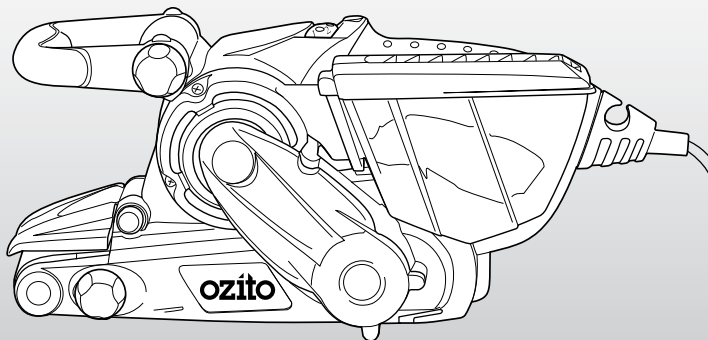

#### WHAT'S IN THE BOX



**Belt Sander**

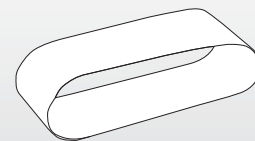

**Sanding Belt**

**3** YEAR REPLACEMENT WARRANTY

**BSV-9000**

## WARRANTY

IN ORDER TO MAKE A CLAIM UNDER THIS WARRANTY YOU MUST RETURN THE PRODUCT TO YOUR NEAREST BUNNINGS WAREHOUSE WITH YOUR BUNNINGS REGISTER RECEIPT. PRIOR TO RETURNING YOUR PRODUCT FOR WARRANTY PLEASE TELEPHONE OUR CUSTOMER SERVICE HELPLINE:

**Australia 1800 069 486**

**New Zealand 0508 069 486**

TO ENSURE A SPEEDY RESPONSE PLEASE HAVE THE MODEL NUMBER AND DATE OF PURCHASE AVAILABLE. A CUSTOMER SERVICE REPRESENTATIVE WILL TAKE YOUR CALL AND ANSWER ANY QUESTIONS YOU MAY HAVE RELATING TO THE WARRANTY POLICY OR PROCEDURE.

The benefits provided under this warranty are in addition to other rights and remedies which are available to you at law.

Our goods come with guarantees that cannot be excluded at law. You are entitled to a replacement or refund for a major failure and for compensation for any other reasonably foreseeable loss or damage. You are also entitled to have the goods repaired or replaced if the goods fail to be of acceptable quality and the failure does not amount to a major failure.

Generally you will be responsible for all costs associated with a claim under this warranty, however, where you have suffered any additional direct loss as a result of a defective product you may be able to claim such expenses by contacting our customer service helpline above.

### 3 YEAR REPLACEMENT WARRANTY

Your product is guaranteed for a period of **36 months from the original date of purchase** and is intended for DIY (Do It Yourself) use only. If a product is defective it will be replaced in accordance with the terms of this warranty. Warranty excludes consumable parts, for example: sand paper, carbon brushes etc.

### WARNING

**The following actions will result in the warranty being void.**

- If the tool has been operated on a supply voltage other than that specified on the tool.
- If the tool shows signs of damage or defects caused by or resulting from abuse, accidents or alterations.
- Failure to perform maintenance as set out within the instruction manual.
- If the tool is disassembled or tampered with in any way.
- Professional, industrial or high frequency use.

# KNOW YOUR PRODUCT

## BELT SANDER

- |                                |                              |
|--------------------------------|------------------------------|
| 1 Adjustable Front Handle      | 5 ON/OFF Trigger (not shown) |
| 2 Belt Tracking Knob           | 6 Lock-on Switch (not shown) |
| 3 Sanding Guard Release Button | 7 Dust Canister              |
| 4 Handle Locking Knob          | 8 Variable Speed Dial        |

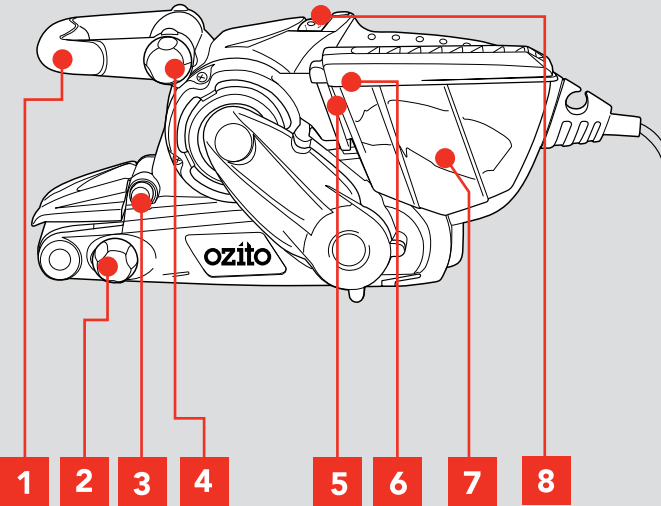

## ACCESSORIES

- 9 Sanding belt (fitted)

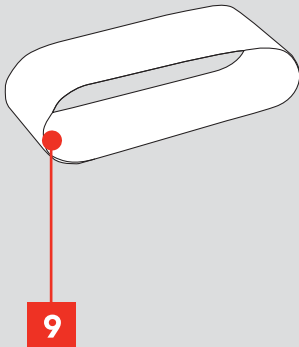

## ONLINE MANUAL

Scan this QR Code with your mobile device to take you to the online manual.



# SETUP & PREPARATION

## 1. DUST CANISTER

Ensure the tool is disconnected from the power supply before performing any of the following operations.

1. Slide the dust canister down onto the dust extraction port.

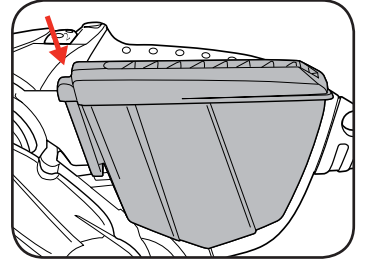

2. To remove, slide the dust canister up off the dust extraction port.

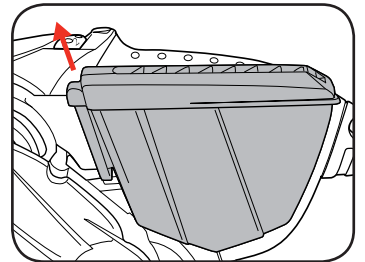

3. Regularly check the dust canister and empty when it becomes 1/3 full for optimum dust extraction.

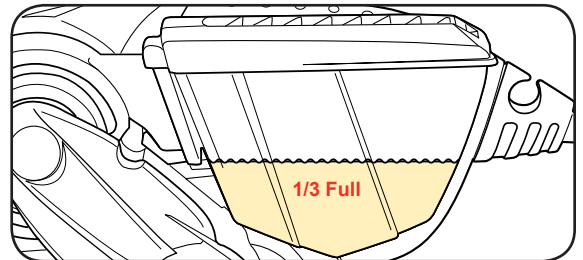

### To Adjust the Front Handle

1. Loosen the handle locking knob.
2. Move the handle into your desired position.

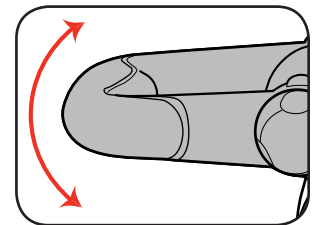
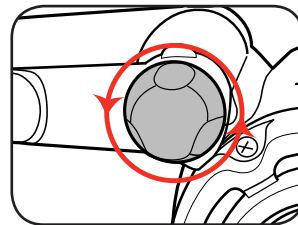

3. Tighten the handle locking knob to secure this position.

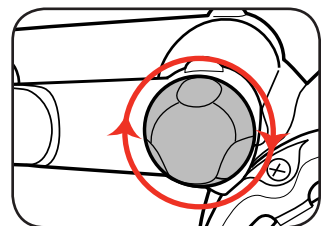

# 3 YEAR REPLACEMENT WARRANTY

# OPERATION

## 2. SANDING BELT

### Install

When installing a belt, ensure you have the correct size for your belt sander, and correct grit for your workpiece. Belts have arrows marked on them to assist in fitting them to the belt sander in the correct direction. Belts are also marked with a grit rating.

1. Place the belt sander on its left side on a flat surface.
2. Pull the belt tension lever out, toward the front of the sander.

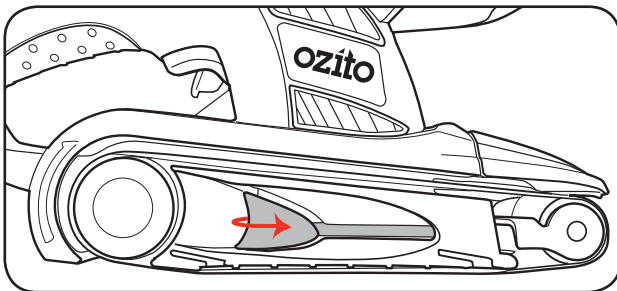

3. Gently place the belt over the front and rear rollers.

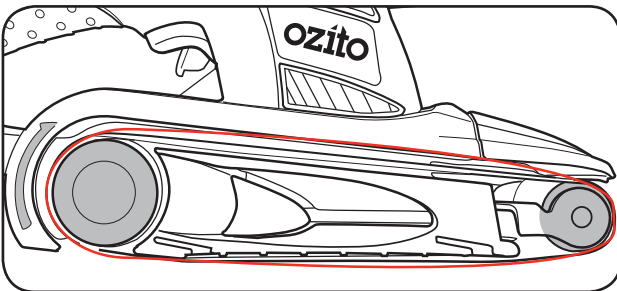

**CAUTION:** The arrows on the belt must be aligned with the markings on the belt sander. Incorrect fitment could cause the belt to break. Belts are not covered by the warranty.

4. Close the belt tension lever.

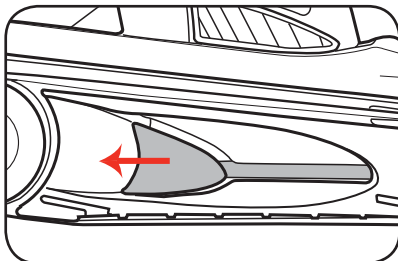

Follow the above procedure to remove a sanding belt, removing the belt in step 3 instead of placing the belt.

## 3. BELT ADJUSTMENT

### Tracking Adjustment

**CAUTION:** Ensure body parts, cords, workpieces and any loose items are clear of the sanding belt before performing the tracking adjustment operation

It is necessary to ensure the belt is tracking correctly, in a straight line, to avoid the belt 'tracking off' the belt sander's rollers.

1. Turn the sander upside down and hold it firmly with one hand. Press the on/off switch to start the sander and observe the tracking of the sanding belt.

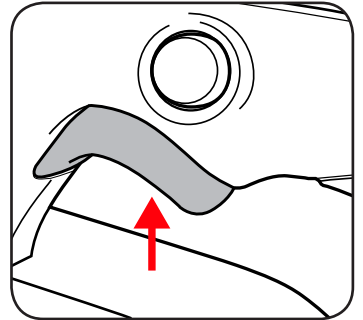

2. If the belt tracks outward, turn the belt tracking knob clockwise. If the belt tracks inward turn the belt tracking knob counter clockwise. the belt sander.

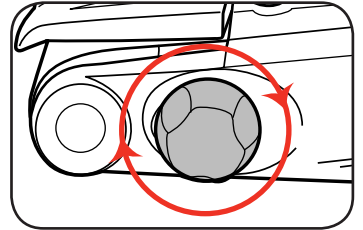

3. Adjust the belt until its outer edge is even with the outer edge of the front and rear rollers. Make sure the belt does not rub against the rear guide strip. Once the belt stabilizes you can begin operation.

## 4. CONTROLS



**WARNING!** THE POWER SUPPLY FOR THIS PRODUCT SHOULD BE PROTECTED BY A RESIDUAL CURRENT DEVICE (RATED AT 30mA OR LESS).

1. Connect the tool to the mains power supply.
2. To turn the sander on, squeeze the on/off trigger.
3. To turn off, release the on/off trigger.

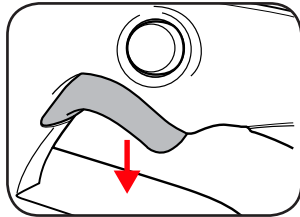
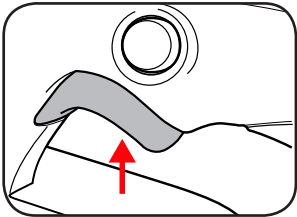

### Lock on Button

The lock on button allows the belt sander to continue operating without having to maintain pressure on the on/off trigger.

1. Squeeze the on/off trigger, then press the lock on button.
2. Release the on/off trigger and then the lock on button.

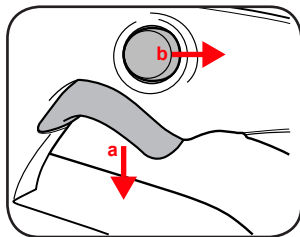
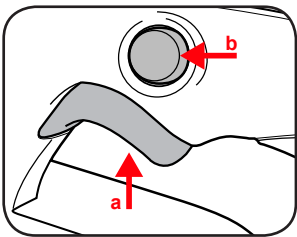

3. To unlock, squeeze and release the on/off trigger.

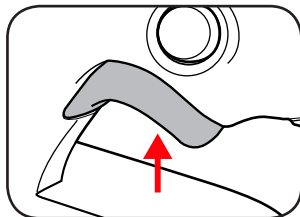

### Variable Speed Dial

1. Rotate the dial clockwise to select a higher speed or anti-clockwise to lower the speed. Align the number with the marker on the tool housing.

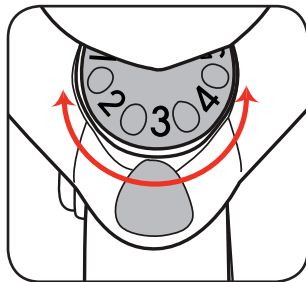

## 5. SANDING

1. Secure the material to be sanded.
2. Firmly grasp the sander. Gently place the rear heel of the sander on your workpiece, keeping the sanding belt off the work surface.

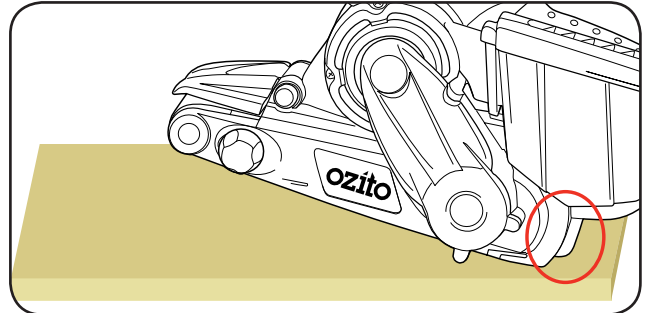

3. Turn the sander on.

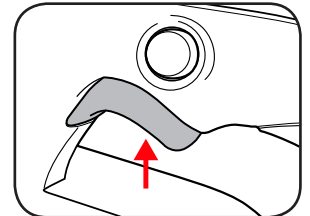

4. Wait for the belt to reach maximum speed, then gradually lower it onto the workpiece.

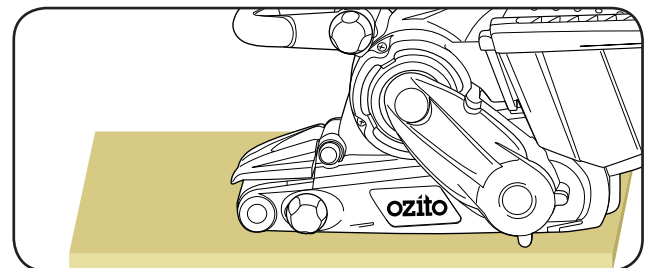

**CAUTION:** GUIDE THE CORD DURING SANDING TO PREVENT IT BEING CAUGHT ON THE WORKPIECE, OR OTHER OBJECTS.

5. Use a back and forth motion. Do not apply pressure on the sander. Allow the sander to do the work.

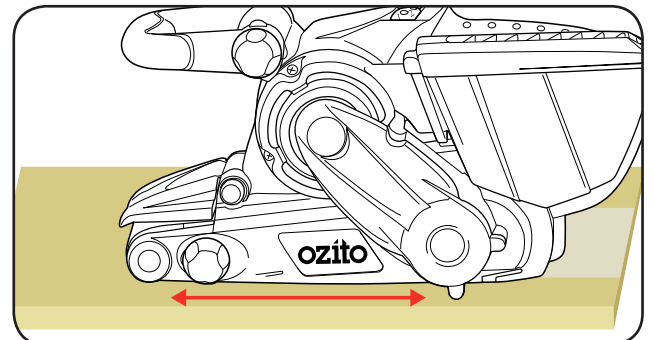

# MAINTENANCE

- Keep the ventilation vents of the sander clean at all times, if possible, prevent foreign matter from entering the vents.
- After each use, blow air through the sander housing to ensure it is free from all dust particles which may build up. Build up of dust particles may cause the sander to overheat and fail.
- If the enclosure of the sander requires cleaning, do not use solvents but a moist soft cloth only. Never let any liquid get inside the sander; never immerse any part of the sander into a liquid.

## Carbon Brushes



When the carbon brushes wear out, the sander will spark and/or stop. Discontinue use as soon as this happens. They should be replaced prior to recommencing use of the sander. Carbon brushes are a wearing component of the sander therefore not covered under warranty. Continuing to use the sander when carbon brushes need to be replaced may cause permanent damage to the sander. Carbon brushes

will wear out after many uses but when the carbon brushes need to be replaced, take the sander to an electrician or a power tool repairer for a quick and low cost replacement. Always replace both carbon brushes at the same time.

*Note: Ozito Industries will not be responsible for any damage or injuries caused by the repair of the sander by an unauthorised person or by mishandling of the sander.*

### IMPORTANT:

If the motor on your belt sander operates but the belt does not rotate, follow these instructions. In most cases, it isn't necessary to return the product back to the store. Check that the drive belt has not been damaged. If it is damaged or broken, contact Ozito Customer Service for a new drive belt. Once you have received your new drive belt, please follow the instructions below.

1. To remove and check the drive belt, remove the 4 screws from the belt cover. If the belt is damaged, worn or broken, replace with a new drive belt.
2. To remove drive belt, simply use a pair of scissors to cut the drive belt.

**Note:** DO NOT pry the belt off the pulley as this may damage the housing.

3. To fit the new drive belt, place it around the large belt wheel. Align the ridges on the belt with the teeth on the small gear wheel.
4. Rotate the large belt wheel and push the drive belt down onto the small gear wheel as it rotates. The wheel can be difficult to rotate until the drive belt is fed onto the small gear wheel. Keep rotating the wheel and feed the drive belt onto the small gear wheel until it sits flush with the edge of the wheels.
5. Refit cover and tighten screws. repairer for a quick and low cost replacement. Always replace both carbon brushes at the same time.

*Note: Ozito Industries will not be responsible for any damage or injuries caused by the repair of the sander by an unauthorised person or by mishandling of the sander.*

# DESCRIPTION OF SYMBOLS

<b>V</b>	Volts	<b>Hz</b>	Hertz
<b>~</b>	Alternating current	<b>W</b>	Watts
<b>/min</b>	Revolutions or reciprocation per minute	<b>n<sub>o</sub></b>	No load speed
	Warning		Double insulated
	Regulator compliance mark		Read instruction manual

# TROUBLESHOOTING

## Sparking visible through the housing air vents

A small amount of sparking may be visible through the housing vents. This is normal and does not indicate a problem.

## Excessive sparking visible through the housing air vents and/or the sander failing to operate



May indicate the carbon brushes have worn out and need to be replaced. Carbon brushes should only be replaced by a qualified electrician or power tool repairer.

## Sandpaper Selection

Selecting the correct grit of sandpaper is an important step in achieving optimum results. Coarse grit will remove the most material. Finer grit will produce a smoother finish. The condition of the workpiece will determine the grit of the sandpaper to be used. The higher the grit number, the finer the grade of sandpaper.

If the surface is rough, start with a coarse grit and sand until the surface is uniform. Medium grit may then be used to remove scratches left by the coarser grit. Finer grit is then used to finish the surface. Always continue sanding with each grade of sandpaper until the surface is uniform.

MATERIAL	APPROPRIATE GRIT	
	Coarse Sanding	Fine Sanding
Paintwork	180	400
Wood:	Softwood	60
	Hardwood	60
Veneer	240	320

**Note:** If intermediate sanding is required, choose a grit rating between coarse and fine. The above table is intended as a guide only. To ensure a satisfactory result, a small, inconspicuous area should first be tested to ensure the grit of sandpaper chosen is suitable for the desired finish.

# SPARE PARTS

Spare parts can be ordered from the Special Orders Desk at your local Bunnings Warehouse.

For further information, or any parts not listed here, visit [www.ozito.com.au](http://www.ozito.com.au) or contact Ozito Customer Service:

Australia 1800 069 486

New Zealand 0508 069 486

E-mail: [enquiries@ozito.com.au](mailto:enquiries@ozito.com.au)

# CARING FOR THE ENVIRONMENT



Power tools that are no longer usable should not be disposed of with household waste but in an environmentally friendly way. Please recycle where facilities exist. Check with your local council authority for recycling advice.



Recycling packaging reduces the need for landfill and raw materials. Reuse of recycled material decreases pollution in the environment. Please recycle packaging where facilities exist. Check with your local council authority for recycling advice.



# ELECTRICAL SAFETY

 **WARNING!** When using mains-powered tools, basic safety precautions, including the following, should always be followed to reduce risk of fire, electric shock, personal injury and material damage.

Read the whole manual carefully and make sure you know how to switch the tool off in an emergency, before operating the tool.

Save these instructions and other documents supplied with this tool for future reference.

The electric motor has been designed for 230V and 240V only. Always check that the power supply corresponds to the voltage on the rating plate.

Note: The supply of 230V and 240V on Ozito tools are interchangeable for Australia and New Zealand.



This tool is double insulated in accordance with AS/NZS 60745-1; therefore no earth wire is required.

If the supply cord of this power tool is damaged, it must be replaced by a specially prepared cord available through the service organization.

**Note:** Double insulation does not take the place of normal safety precautions when operating this tool. The insulation system is for added protection against injury resulting from a possible electrical insulation failure within the tool.

## Using an Extension Lead

Always use an approved extension lead suitable for the power input of this tool. Before use, inspect the extension lead for signs of damage, wear and ageing. Replace the extension lead if damaged or defective.

When using an extension lead on a reel, always unwind the lead completely. Use of an extension lead not suitable for the power input of the tool or which is damaged or defective may result in a risk of fire and electric shock.

To reduce the risk of electrical shock, a residual current device (rated 30mA or less) must be used.

# GENERAL POWER TOOL SAFETY WARNINGS - PERSONAL SAFETY

 **WARNING!** Read all safety warnings and all instructions. Failure to follow the warnings and instructions may result in electric shock, fire and/or serious injury.

Save all warnings and instructions for future reference. The term "power tool" in the warnings refers to your mains-operated (corded) power tool or battery-operated (cordless) power tool.

## 1. Work area safety

- Keep work area clean and well lit. Cluttered or dark areas invite accidents.
- Do not operate power tools in explosive atmospheres, such as in the presence of flammable liquids, gases or dust. Power tools create sparks which may ignite the dust or fumes.
- Keep children and bystanders away while operating a power tool. Distractions can cause you to lose control.

## 2. Electrical safety

- Power tool plugs must match the outlet. Never modify the plug in any way. Do not use any adapter plugs with earthed (grounded) power tools. Unmodified plugs and matching outlets will reduce risk of electric shock.
- Avoid body contact with earthed or grounded surfaces, such as pipes, radiators, ranges and refrigerators. There is an increased risk of electric shock if your body is earthed or grounded.
- Do not expose power tools to rain or wet conditions. Water entering a power tool will increase the risk of electric shock.
- Do not abuse the cord. Never use the cord for carrying, pulling or unplugging the power tool. Keep cord away from heat, oil, sharp edges or moving parts. Damaged or entangled cords increase the risk of electric shock.
- When operating a power tool outdoors, use an extension cord suitable for outdoor use. Use of a cord suitable for outdoor use reduces the risk of electric shock.
- If operating a power tool in a damp location is unavoidable, use a residual current device (RCD) protected supply. Use of an RCD reduces the risk of electric shock.

## 3. Personal safety

- Stay alert, watch what you are doing and use common sense when operating a power tool. Do not use a power tool while you are tired or under the influence of drugs, alcohol or medication. A moment of inattention while operating power tools may result in serious personal injury.
- Use personal protective equipment. Always wear eye protection. Protective equipment such as dust mask, non-skid safety shoes, hard hat, or hearing protection used for appropriate conditions will reduce personal injuries.

- Prevent unintentional starting. Ensure the switch is in the off-position before connecting to power source and/or battery pack, picking up or carrying the tool. Carrying power tools with your finger on the switch or energising power tools that have the switch on invites accidents.
  - Remove any adjusting key or wrench before turning the power tool on. A wrench or a key left attached to a rotating part of the power tool may result in personal injury.
  - Do not overreach. Keep proper footing and balance at all times. This enables better control of the power tool in unexpected situations.
  - Dress properly. Do not wear loose clothing or jewellery. Keep your hair, clothing and gloves away from moving parts. Loose clothes, jewellery or long hair can be caught in moving parts.
  - If devices are provided for the connection of dust extraction and collection facilities, ensure these are connected and properly used. Use of dust collection can reduce dust-related hazards.
- ## 4. Power tool use and care
- Do not force the power tool. Use the correct power tool for your application. The correct power tool will do the job better and safer at the rate for which it was designed.
  - Do not use the power tool if the switch does not turn it on and off. Any power tool that cannot be controlled with the switch is dangerous and must be repaired.
  - Disconnect the plug from the power source and/or the battery pack from the power tool before making any adjustments, changing accessories, or storing power tools. Such preventive safety measures reduce the risk of starting the power tool accidentally.
  - Store idle power tools out of the reach of children and do not allow persons unfamiliar with the power tool or these instructions to operate the power tool. Power tools are dangerous in the hands of untrained users.
  - Maintain power tools. Check for misalignment or binding of moving parts, breakage of parts and any other condition that may affect the power tool's operation. If damaged, have the power tool repaired before use. Many accidents are caused by poorly maintained power tools.
  - Keep cutting tools sharp and clean. Properly maintained cutting tools with sharp cutting edges are less likely to bind and are easier to control.
  - Use the power tool, accessories and tool bits etc. in accordance with these instructions, taking into account the working conditions and the work to be performed. Use of the power tool for operations different from those intended could result in a hazardous situation.
- ## 5. Service
- Have your power tool serviced by a qualified repair person using only identical replacement parts. This will ensure that the safety of the power tool is maintained.

# BELT SANDER SAFETY WARNINGS

 **WARNING!**

- Hold power tool by insulated gripping surfaces, because the belt may contact its own cord. Cutting a "live" wire may make exposed metal parts of the power tool "live" and could give the operator an electric shock.

Recommendation that the tool always be supplied via a residual current device with a rated residual current of 30 mA or less.

It is recommended that the extension lead is a maximum of 25m in length. Do not use multiple extension leads.

Unplug the sander before changing accessories. Accidental start-ups may occur if the sander is plugged in while changing an accessory.

**Disposing of dust.** Be extremely careful of dust disposal, materials in fine particle form may be explosive. Do not throw sanding dust on an open fire. Spontaneous combustion, may in time, result from a mixture of oil or water with dust particles.

**Always wear eye protection and a dust mask for dusty applications and when sanding overhead.** Sanding particles can be absorbed by your eyes and inhaled easily and may cause health complications.

**Use special precautions when sanding chemically pressure treated timber, paint that may be lead based, or any other materials that may contain carcinogens.** A suitable breathing respirator and protective clothing must be worn by all persons entering the work area. Work should be sealed by plastic sheeting and persons not protected should be kept out until work area is thoroughly cleaned.

**Do not 'wet sand' with this sander.** Liquids entering the motor housing are an electrical shock hazard.

**Keep fingers and clothing away from belt.** They could get cut or wedged between the pulley, belt and motor housing.

**Properly adjust the teacking of belt to avoid it overhanging the housing.**

A running belt overhanging its housing can cause severe lacerations.

**Keep the cord to the side away from the pulleys.** The cord can be dragged into the belt housing and become entangled with the pulleys.



**WARNING!**

Some dust created by power sanding, sawing, grinding, drilling and other construction activities contain chemicals known to cause cancer, birth defects or other reproductive harm.

Some examples of these chemicals are:

- Lead from lead-based paints;
- Crystalline silica from bricks, cement and other masonry products, and;
- Arsenic and chromium from chemically-treated timber.

Your risk from these exposures varies, depending on how often you do this type of work. To reduce your exposure to these chemicals: work in a well ventilated area and work with approved safety equipment, such as dust masks that are specially designed to filter out microscopic particles.