

ozito

HIGH PRESSURE PETROL WATER PUMP

196CC 4 STROKE

INSTRUCTION MANUAL

SPECIFICATIONS

Motor:	4.85kW (6.5HP)
Engine:	4 Stroke, air cooled
Fuel Type:	Unleaded
Fuel Tank Capacity:	3.6L
Engine Capacity:	196cc
Max. Flow Rate:	17,000l/h
Max. Head:	55m
Max. Lift:	6m
Inlet/Outlet:	40mm (1½")
Spark Plug:	Champion L90C
Weight:	28kg

ozito.com.au

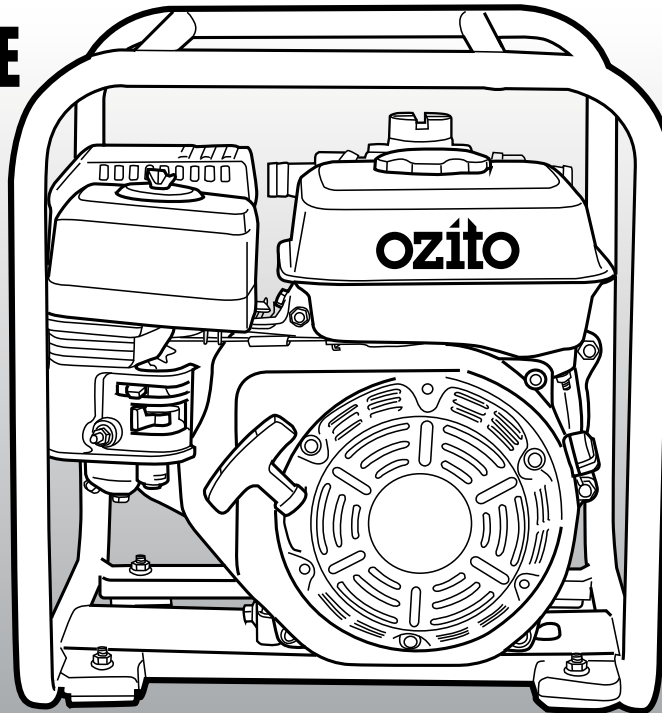

WHAT'S IN THE BOX

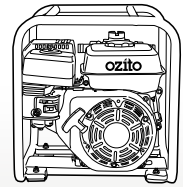

Petrol Pump

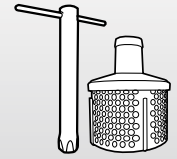

Spark Plug Wrench & Filter

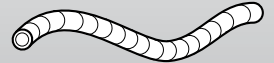

Suction Hose

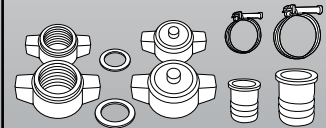

Fasteners & Adaptors

1

YEAR WARRANTY

PTP-065

WARRANTY

IN ORDER TO MAKE A CLAIM UNDER THIS WARRANTY YOU MUST RETURN THE PRODUCT TO YOUR NEAREST BUNNINGS WAREHOUSE WITH YOUR BUNNINGS REGISTER RECEIPT. PRIOR TO RETURNING YOUR PRODUCT FOR WARRANTY PLEASE TELEPHONE OUR CUSTOMER SERVICE HELPLINE:

Australia 1800 069 486

New Zealand 0508 069 486

TO ENSURE A SPEEDY RESPONSE PLEASE HAVE THE MODEL NUMBER AND DATE OF PURCHASE AVAILABLE. A CUSTOMER SERVICE REPRESENTATIVE WILL TAKE YOUR CALL AND ANSWER ANY QUESTIONS YOU MAY HAVE RELATING TO THE WARRANTY POLICY OR PROCEDURE.

The benefits provided under this warranty are in addition to other rights and remedies which are available to you at law.

Our goods come with guarantees that cannot be excluded at law. You are entitled to a replacement or refund for a major failure and for compensation for any other reasonably foreseeable loss or damage. You are also entitled to have the goods repaired or replaced if the goods fail to be of acceptable quality and the failure does not amount to a major failure.

Generally you will be responsible for all costs associated with a claim under this warranty, however, where you have suffered any additional direct loss as a result of a defective product you may be able to claim such expenses by contacting our customer service helpline above.

1 YEAR WARRANTY

Your product is guaranteed for a period of **12 months from the original date of purchase** and is intended for DIY (Do It Yourself) use only. If a product is defective it will be repaired in accordance with the terms of this warranty. Warranty excludes consumable parts, for example: o-rings, bearing, seals, gaskets and adaptors.

WARNING

The following actions will result in the warranty being void.

- If the tool has been operated on a supply voltage other than that specified on the tool.
- If the tool shows signs of damage or defects caused by or resulting from abuse, accidents or alterations.
- Failure to perform maintenance as set out within the instruction manual.
- If the tool is disassembled or tampered with in any way.

KNOW YOUR PRODUCT

PETROL HIGH PRESSURE WATER PUMP

- | | | |
|---------------|------------------|-------------------|
| 1 Exhaust | 5 Recoil Starter | 9 Motor Housing |
| 2 Air Filter | 6 Priming Cap | 10 Throttle Lever |
| 3 Choke Lever | 7 Fuel Cap | |
| 4 Fuel Lever | 8 Fuel Tank | |

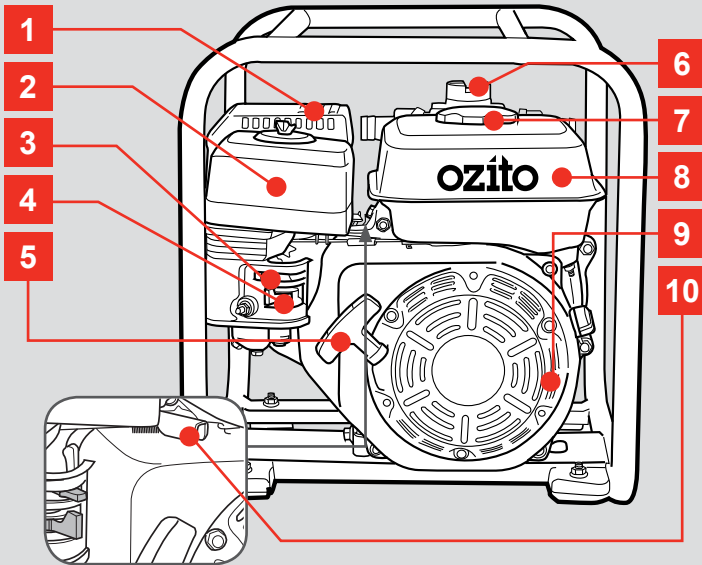

- | | | |
|-------------------|---------------------|-----------------|
| 11 On/Off Switch | 14 Spark Plug | 17 Pump Housing |
| 12 Low Oil Sensor | 15 Discharge Outlet | 18 Drain Screw |
| 13 Oil Fill Plug | 16 Suction Inlet | |

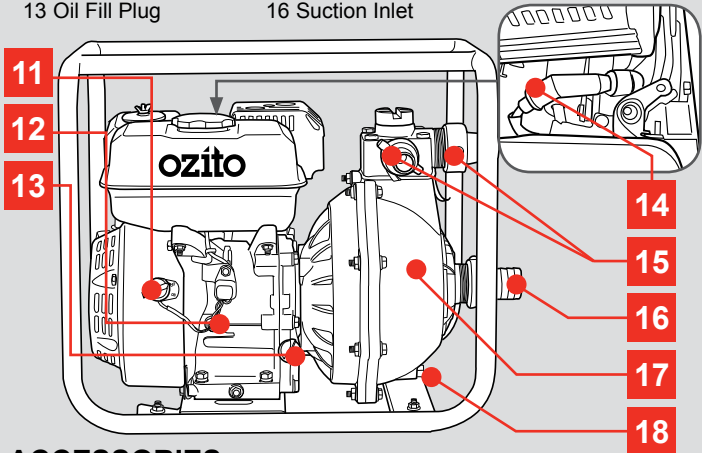

ACCESSORIES

- | | |
|----------------------|------------------|
| 19 Spark Plug Wrench | 23 O-rings |
| 20 Filter | 24 Outlet Caps |
| 21 5m Suction Hose | 25 Hose Adaptors |
| 22 Collars | 26 Hose Clamps |

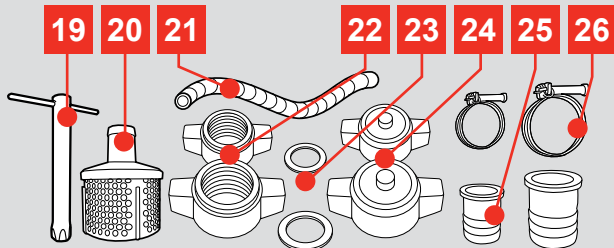

ONLINE MANUAL

Scan this QR Code with your mobile device to take you to the online manual.



SETUP & PREPARATION

1. CONNECTING THE INLET



WARNING! ENSURE THE ENGINE IS SHUT OFF AND THE ON/OFF SWITCH IS IN THE OFF POSITION BEFORE PERFORMING ANY OF THE FOLLOWING ASSEMBLY.

Removing the Protection Covers

The pump inlet and outlet has been fitted with a protection cover for transportation. These will need to be removed before connecting any pipes.

Connecting the Suction Inlet

The inlet allows for a 40mm (1 1/2") supply line to be connected and is capable of a maximum suction height of 6m.

- 1 Place the filter assembly into the intake end of a suction hose and secure with a hose clamp tightly.

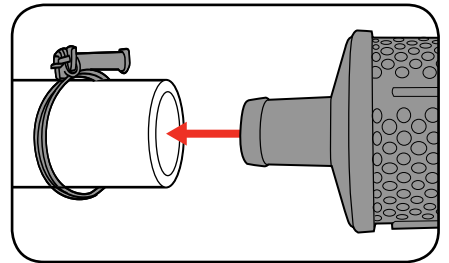

- 2 Insert a hose adaptor and an o-ring into one of the collars and fasten to the outlet side of the suction hose using a hose clamp.

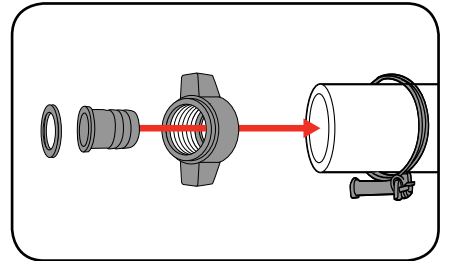

- 3 Screw the hose adaptor and collar tightly onto the pumps inlet in a clockwise direction to secure in place.

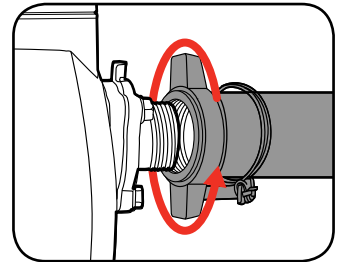

Note: Teflon tape (not supplied) is recommended on threads to ensure a water tight seal and prevent any leakage.



CAUTION: THE INPUT HOSE OR PIPE SHOULD BE LOW ENOUGH IN THE WATER TO ENSURE THAT IF THE WATER LEVEL FALLS, THE PUMP WILL NOT RUN DRY. ENSURE THAT THIS IS CHECKED WHEN IN OPERATION.



CAUTION: AVOID POSITIONING THE INLET PIPE HIGHER THAN THE PUMP, AS THIS WOULD DELAY THE ESCAPE OF AIR BUBBLES FROM THE INLET PIPE.

1 YEAR WARRANTY

2. CONNECTING THE OUTLET

Connecting the Discharge Outlet

The outlet allows for a 25.4mm (1") and 40mm (1^{1/2}") pipe to be connected and is capable of a maximum head of 55m.

The pump has 3 outlets (2x 25.4mm and 1x 40mm), which allows for multiple outlets to be used to pump water simultaneously, however this will result in lower pressure and flow rate.



CAUTION: ALL CONNECTIONS MUST BE AIR TIGHT, FAILURE TO DO SO MAY RESULT IN AN AIR LEAK WHICH CAN PREVENT THE PUMP FROM PRIMING.

- 1 Insert a hose adaptor and an o-ring into one of the collars.

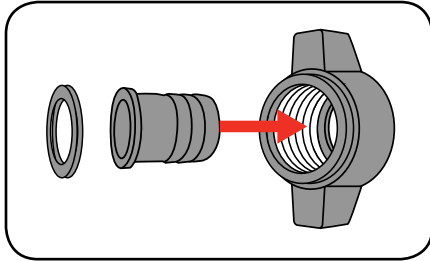

- 2 Screw the hose adaptor and collar tightly onto one of the pump outlets in a clockwise direction to secure in place.

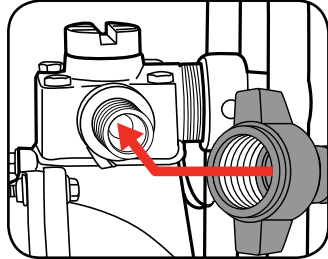

Note: Teflon tape (not supplied) is recommended on threads to ensure a water tight seal and prevent any leakage.

- 3 Repeat this process to fit multiple outlets. Ensure unused outlets are fitted with the supplied outlet caps to stop water from expelling out of the discharge outlets.

NOTE: TO USE THE PUMP IN PERMANENT INSTALLATIONS WITH RIGID PIPES, INSTALL A NON-RETURN VALVE TO AVOID THE FLUID BEING RE-CIRCULATED ONCE THE PUMP HAS STOPPED.

3. INSTALLATION



CAUTION: ALWAYS CARRY OR LIFT THE PUMP BY THE FRAME TO AVOID DAMAGING THE UNIT.

Before starting, perform a few simple checks:

- 1 Ensure the pump is mounted to a rigid base or ground.
- 2 Ensure the distance from the surface of the water to the pump inlet does not exceed 6m.
- 3 Ensure the distance from the pump to the highest point that you wish to deliver the water does not exceed 20 metres.

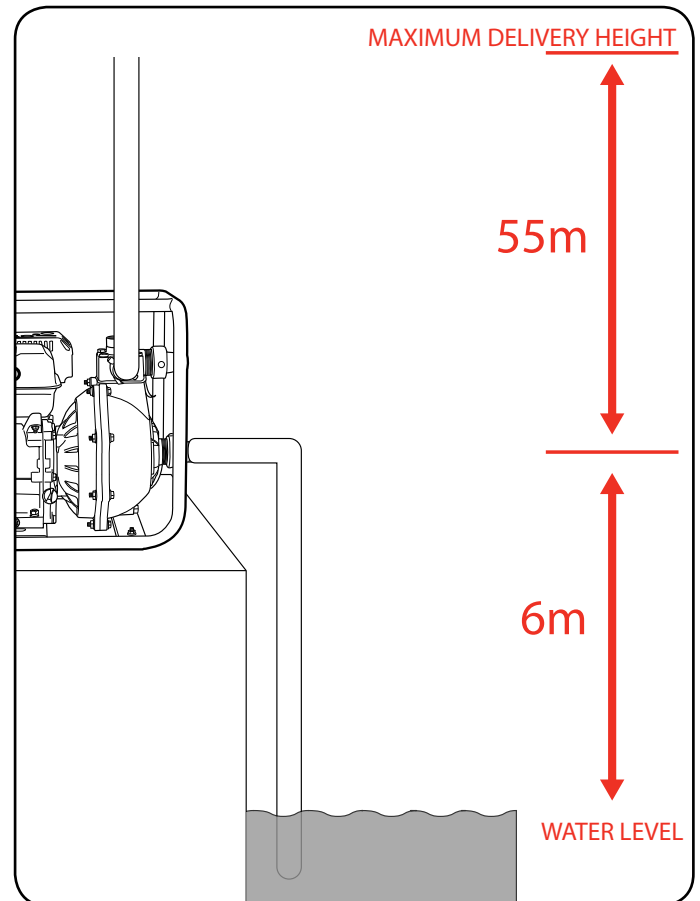

CAUTION: THIS PRODUCT IS INTENDED FOR PUMPING WATER IN A HOME DOMESTIC APPLICATION. DO NOT USE IT FOR CORROSIVE, ABRASIVE, EXPLOSIVE OR DANGEROUS LIQUIDS.



WARNING: ENSURE THE OUTLET FOR THIS PUMP, INCLUDING ANY HOSES OR PIPES ARE NOT RESTRICTED OR OBSTRUCTED IN ANY WAY. TAPS, VALVES AND ANY TYPE OF TRIGGER NOZZLE MUST NEVER BE USED WITH THIS PUMP. FAILURE TO FOLLOW THESE INSTRUCTIONS MAY RESULT IN PUMP FAILURE OR SERIOUS INJURY.

OPERATION

4. PRIMING THE PUMP FOR OPERATION

Priming the pump prepares the motor for safe operation.

CAUTION: DO NOT RUN THE PUMP DRY, THIS MAY RESULT IN DAMAGE TO THE PUMP.

- 1 Unscrew the priming cap by turning in an anti-clockwise direction.

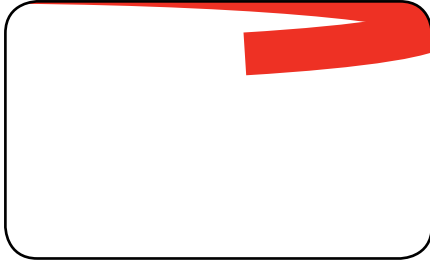

- 2 Using a hose, fill the pump by pouring water into the priming plug hole. Ensure that the pump and suction line are full.

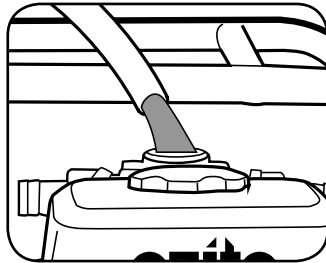

- 3 Fit the priming cap back on and ensure it is secure.

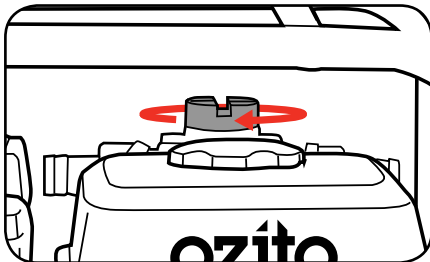

5. FUEL & OIL

Adding Fuel

WARNING! BE SURE TO STOP THE ENGINE AND THE ON/OFF SWITCH IS IN THE OFF POSITION BEFORE REFUELLING. DO NOT SMOKE WHILE REFUELLING.

Only use unleaded 91 RON (Research Octane Number) petrol. Purchase fuel in quantities that can be used every 30 days to prevent gum or foaming inside the container and/or fuel tank.

- 1 Remove the fuel cap by rotating anti-clockwise.

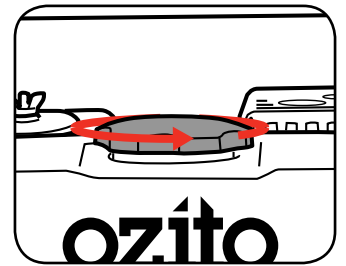

- 2 Fill the fuel tank with the unleaded petrol.

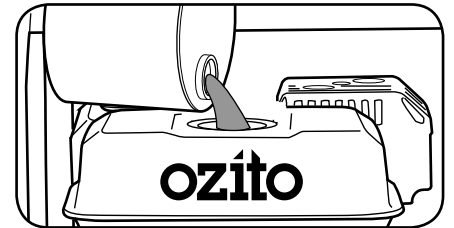

- 3 Place the fuel cap back on.

WARNING! DO NOT OVER FILL THE FUEL TANK.

Adding Oil

After the first 25 hours of use the engine oil requires to be replaced, and then every 50 hours after that. It is recommended that SAE-10W-30 (multi viscosity) oils are used at temperatures from 5 to 35°C and synthetic oils 5W-30 (multi viscosity) is used for temperatures -5 to 5°C.

- 1 Remove the oil fill plug from both the left and right side of the engine. Clean the dip stick and re-insert without screwing down.

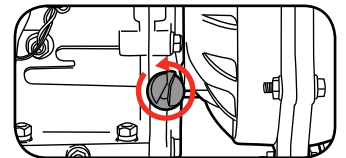

- 2 Remove the dipstick and ensure the oil lays between the min and max marks.

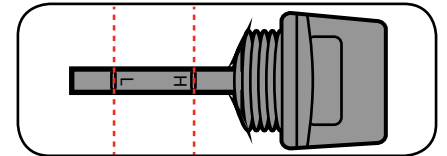

- 3 If oil needs to be added simply pour oil in until the level reaches the max level of the oil gauge.

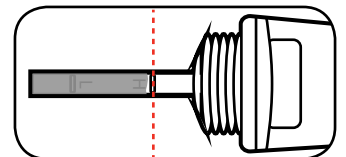

- 4 Ensure dipstick is securely tighten after oil has been topped up.

6. PRE-OPERATION INSPECTION

Air Filter

The air filter must always be in perfect working order, to prevent debris and dust from being sucked into the engine thus reducing the efficiency and life of the machine.

- 1 Ensure the filter is free from any debris.

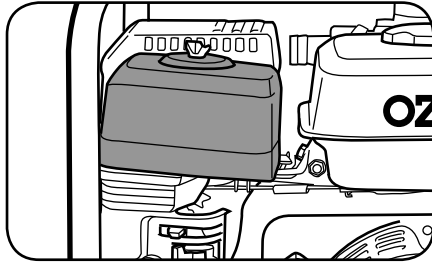

- 2 If necessary clean or replace the filter by following the steps outlined in the maintenance section of this manual.

Spark Plugs

Use only the spark plugs that are recommended for this petrol pump: Champion L90C.

Note: Using a spark plug other than that specified could lead to serious engine damage.

- 1 Make sure the electrode is clean and the air gap is correct (refer to the specs of the spark plug manufacture).

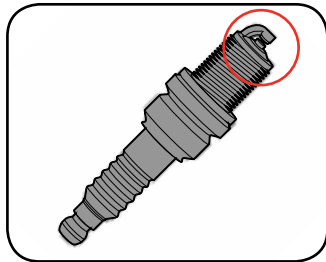

- 2 To remove and install the spark plug refer to the maintenance section of this manual.

7. STARTING & STOPPING ENGINE

Starting the Engine

- 1 Move the choke to the left (closed position) and the fuel lever to the right (open position).

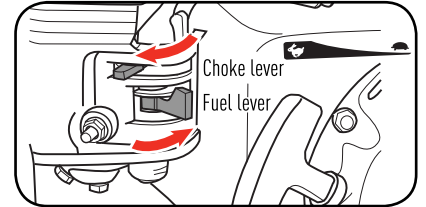

- 2 Move the throttle lever to the left (fast position).

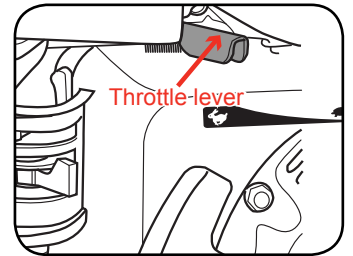

- 3 Turn the engine on/off switch to the on position.

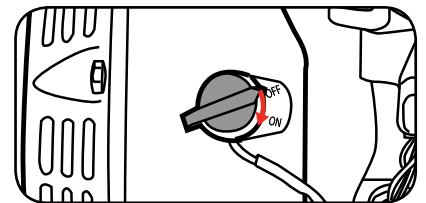

- 4 Grip the recoil starter and slowly pull until resistance is felt, then pull the recoil starter rapidly. Allow the rope to rewind slowly and if necessary, repeat this procedure until the engine starts.

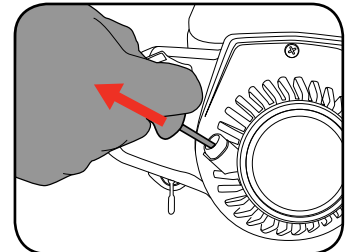

- 5 Once started move the choke lever to the right (open position) and the throttle lever to the right (slow position) and allow to idle for 3 minutes.

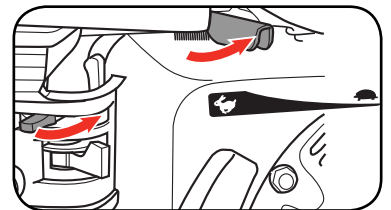

Stopping the Engine

- 1 Decrease the speed of the engine by moving the throttle to the right and allow to idle for 10-20 seconds.

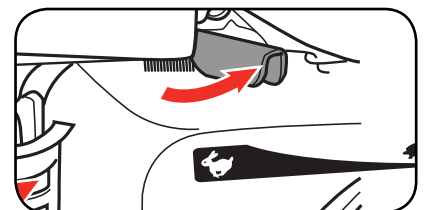

- 2 Turn the on/off switch to the off position and move the fuel lever to the left (closed position).

Note: Allow the engine to cool down before moving or storing the pump.

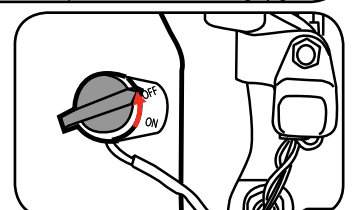



OPERATION

8. ADJUSTING THROTTLE

The throttle is used to regulate the rotational speed of the engine, which also controls the water flow out of the discharge outlet.

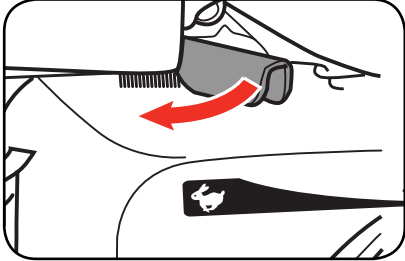
- 1 To increase the speed of the engine and water flow, move the throttle lever left towards the “” indicator.



- 2 To decrease the speed of the engine and water flow, move the throttle lever right towards the “” indicator.

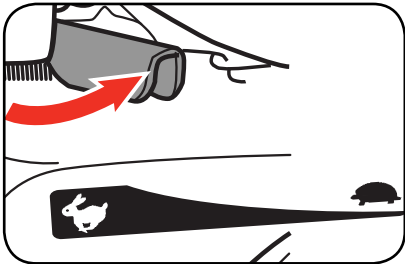

9. MAINTENANCE

Storing the Pump

Before storing the pump, it is recommended to empty the pump body of any water.

Turn the drain screw anti-clockwise and remove from the pump body to allow excess water to drain out.

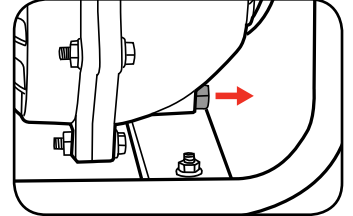

Ensure that the drain screw is fitted once all water has drained out.

Replacing the Air Filter

- 1 Unscrew and remove the air filter wing nut and washer.

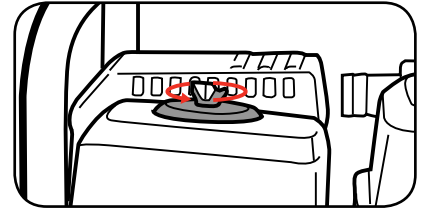

- 2 Remove the cover and the air filter. Check that the filter is intact and clean, if not rinse with water and allow to dry or replace the filter.

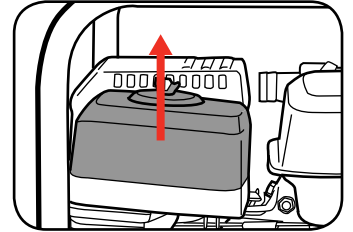

- 3 Insert the filter and secure with the filter cover and nut.

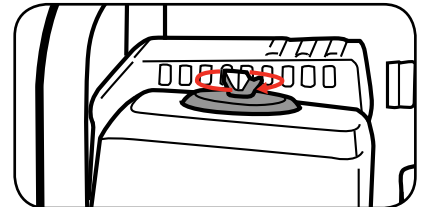

Replacing the Spark Plug

- 1 Remove the spark plug lead.

- 2 Remove the spark plug using the spark plug wrench supplied by turning anti-clockwise.

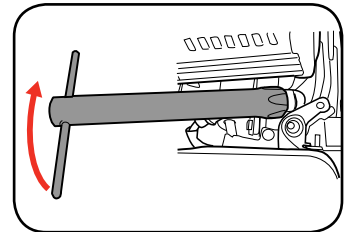

- 3 Clean the electrode with a metal brush and remove any carbon build-up or replace the spark plug.

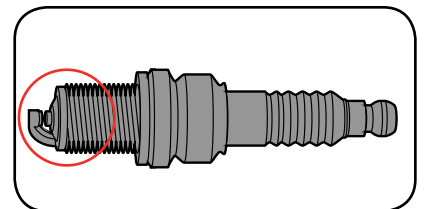

- 4 Refit the spark plug using the spark plug wrench and press the spark plug lead back on.

MAINTENANCE CHART

Recommended Check & Maintenance Chart

Item \ Time	Every operation / daily	After 20 hours or 1 month	After 50 hours or 3 months	After 100 hours or yearly
Inspect and tighten all nuts and bolts	⊙			
Air Filter		○ (Frequency depends on pump location. i.e. High dust environment every 10 Hrs)		
Fuel Tank		○		
Fuel Tank Nozzle			●	
Fuel lines	⊙ (check for leaks)			⊙ (change if necessary)
Spark Plug	⊙		●	
Adjust inlet and exhaust valves		⊙ (required after first 20 hours / 1 month of use)		⊙ *
Remove carbon in combustion chamber				⊙ *

⊙ Check ● Change ○ Clean * To be performed by qualified service centre

TROUBLESHOOTING

Problem	Possible Cause	Solution
Unit runs but delivers little or no water	Leak in suction hose or piping Clogged suction filter Water level above pump intake Pump not primed Water level more than maximum lift Engine speed too low	Tighten suction hoses and use thread sealer. Clear debris from suction filter Lower suction hose into water Fill pump with water before trying to prime Move pump closer to water level and increase discharge line length if necessary Increase throttle
Unit will not start	Engine switch OFF No fuel Fuel tap in "off" position Oil level too low Low quality or deteriorated, old fuel Dirty muffler, exhaust Choke adjusted incorrectly Air-filter clogged Fuel evaporation in carburettor (vapour lock) due to high temperatures Spark plug is wet or the spark plug electrode is dirty, placed inadequately or is faulty	Turn engine switch ON Fill engine fuel tank. Refer to engine operating instructions Turn fuel valve to "on" position Fill with correct oil Use only fresh 91 octane unleaded fuel. Check and clean Move choke lever to "OPEN" unless engine is warm. Refer to engine operating instructions Check, clean or replace filter as required Wait 10 to 20 minutes then retry the starting procedure Refer to the maintenance section on how to remove and inspect
Unit starts but runs and performs poorly	Air-filter clogged Choke is still engaged Engine or carburettor difficulties	Check, clean or replace filter as required Return the choke to the open position Contact Ozito customer service

MAINTENANCE

Make sure to shut off the engine, allow the engine to cool before performing maintenance procedures.

Use a moist cloth to wipe down the pump housing. Allow to dry thoroughly before storing in a dry location that is protected from bad weather conditions.

Note: Ozito will not be responsible for any damage or injuries caused by repair of the pump by an unauthorised person or by mishandling.

DISPOSAL AND RECYCLING



Power tools that are no longer usable should not be disposed of with household waste but in an environmentally friendly way. Please recycle where facilities exist. Check with your local council authority for recycling advice.



Recycling packaging reduces the need for landfill and raw materials. Reuse of recycled material decreases pollution in the environment. Please recycle packaging where facilities exist. Check with your local council authority for recycling advice.

GENERAL POWER TOOL SAFETY WARNINGS

 **WARNING!** Read all safety warnings and all instructions. Failure to follow the warnings and instructions may result in electric shock, fire and/or serious injury.
Save these instructions

1. **Work area safety**
 - a. **Keep work area clean and well lit.** Cluttered or dark areas invite accidents.
 - b. **Do not operate pumps in explosive atmospheres, such as in the presence of flammable liquids, gases or dust.** Pumps create sparks which may ignite the dust or fumes.
 - c. **Keep children and bystanders away while operating a pump.** Distractions can cause you to lose control.
2. **Personal safety**
 - a. **Stay alert, watch what you are doing and use common sense when operating a pump. Do not use a pump while you are tired or under the influence of drugs, alcohol or medication.** A moment of inattention while operating a pump may result in serious personal injury.
 - b. **Avoid accidental starting.** Carrying pump with your finger on the recoil starter invites accidents.
3. **Pump use and care**
 - a. **Store idle pump out reach of children and other untrained persons.** Pumps are dangerous in the hands of untrained users.

- b. **Always shut off the engine, allow the engine to cool and remove spark plug before making any adjustments, changing accessories, or storing pumps.** Such preventive safety measures reduce the risk of starting the pump accidentally.
 - c. **Maintain pumps.** Check for misalignment or binding of moving parts, breakage of parts and any other condition that may affect the pumps operation. If damaged, have the pump repaired before use. Many accidents are caused by poorly maintained pumps.
 - d. **Use the pump, and accessories etc., in accordance with these instructions and in the manner intended for the particular type of pump, taking into account the working conditions and the work to be performed.** Use of the pump for operations different from intended could result in a hazardous situation.
4. **Service**
- a. **Have your pump serviced by a qualified repair person using only identical replacement parts.** This will ensure that the safety of the pump is maintained.

ADDITIONAL SAFETY WARNINGS FOR PUMPS

 **WARNING!** This product is intended for pumping water in a Home Domestic application. Do not use it for corrosive, abrasive, explosive or dangerous liquids. Fluids other than water will damage the water pump and/or create a fire hazard. Failure to follow all instructions listed below may result in electric shock, fire and/or serious injury.

 **WARNING!** This product is not suitable for use with drinking (potable) water.

This appliance is not intended for use by person (including children) with reduced physical, sensory or mental capabilities, or lack of experience and knowledge, unless they have been given supervision or instruction concerning use of the appliance by a person responsible for their safety.

Children should be supervised to ensure that they do not play with the appliance.

- Ensure the water pump is switched off when installing.
- Do not install or operate the water pump in an explosive environment or near flammable material.
- Do not operate the water pump without liquid.
- Do not run the water pump dry.
- Never refuel while engine is running or hot. Fuel spilled on a hot engine could result in a fire or explosion.
- Use caution when handling petrol. Refuel in well-ventilated area. Do not overfill fuel tank and do not spill fuel. Make sure tank cap is closed properly. Petrol is extremely flammable and is explosive under certain conditions.
- Never run the engine in an enclosed or confined area. Exhaust contains poisonous carbon monoxide gas; exposure may cause loss of consciousness and may lead to death.

- Do not use to pump flammable or explosive liquids such as gasoline, fuel oil, kerosene, solvents or thinners. Pump should only be used with liquids compatible with pump component materials. Failure to follow to this warning can result in serious personal injury, death and/or property damage.
- Pump must be located on a solid level surface. Pump could tip or fall causing serious injury.
- Do not hold or suspend pump by means of a discharge pipe. Pipe could break or come loose.
- Be careful not to touch the muffler while it is hot. To avoid severe burns or fire hazards, let the engine cool before transporting or storing it indoors. The muffler becomes very hot during operation and remains hot for a while after stopping the engine. Exhaust may contain chemicals that may cause cancer or reproductive harm.

 **WARNING!** The water pump together with associated pipework operate under pressure. Do not disconnect water pump or pipework until internal pressure has been released. Failure to do this could result in personal injury and damage to property.

- Avoid inserting hands into the inlets/outlets of the water pump while it is operating.
- Before using the water pump, always inspect it visually. Do not use the pump if it is cracked and/or damaged. If the water pump is damaged, contact Ozito customer service.
- The pump must not be used when people are in the water.
- Pollution of the liquid could occur due to leakage of lubricants

ORDERING REPLACEMENT PARTS

Air Filter	SPYW65PHP-08019
Fuel Tank Filter	SPYW65PHP-1103
Fuel Tank Cap	SPYW65PHP-1102
On/off Switch	SPYW65PHP-1210
Recoil Starter	SPYW65PHP-0603A

Spare parts can be ordered from the Special Orders Desk at your local Bunnings Warehouse.







For further information, or any parts not listed here, visit

www.ozito.com.au or contact Ozito Customer Service:

Australia 1800 069 486 New Zealand 0508 069 486

E-mail: enquires@ozito.com.au

SYMBOLS

V	Volts	Hz	Hertz
~	Alternating current	W	Watts
/min	Revolutions or reciprocation per minute	n _o	No load speed
Hp	Horse power	°C	Degrees Celsius
cc	Cubic centimeters		Hot surface
	Fire		Toxic fumes
p/hr	Per hour	kPa	Pressure rating (kilopascals)
bar	Pressure rating	L	Litres
F	Insulation class	PVC	Polyvinyl chloride
	Regulator compliance mark	IPX8	Ingress protection from water
	Warning		Read instruction manual