

Operating & Installation Manual

Serene Model S2028-9 Convection Panels

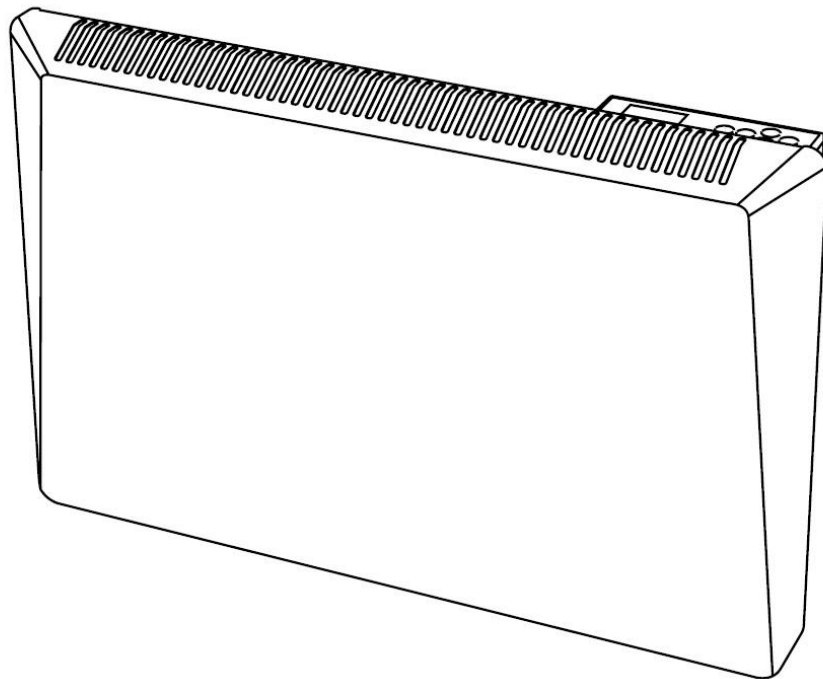

Model S2028 1000 Watts W = 650 mm
Model S2029 2000 Watts W = 1050 mm

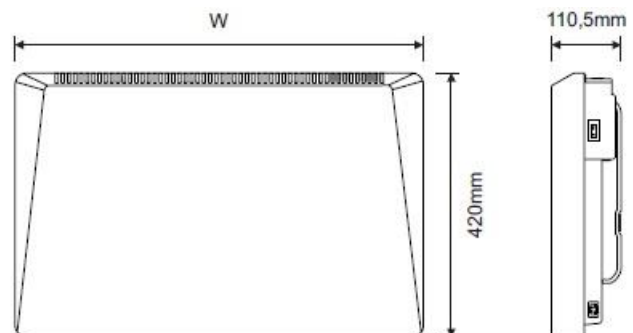

Safety Information:



This appliance is not intended for use by persons (including children) with reduced physical, sensory or mental capabilities, or lack of experience and knowledge, unless they have been given supervision or instruction concerning use of the appliance by a person responsible for their safety.

When using any electrical appliance, safety precautions should always be observed. Read these instructions carefully, and retain for future reference.

WHEN USED BY, OR NEAR, YOUNG CHILDREN OR INFIRM PERSONS, SUPERVISION IS NECESSARY. YOUNG CHILDREN SHOULD BE SUPERVISED TO ENSURE THAT THEY DO NOT PLAY WITH THE APPLIANCE.

- Use this appliance only with the voltage specified on rating label.
- Do **NOT** use this appliance other than for its intended use.
- Do **NOT** touch hot surfaces or moving parts.
- Do **NOT** cover the grilles or place any object or material up against the unit, as this may block entry or exhaust of air.
- Do **NOT** probe any opening.

To ensure trouble free performance it is recommended that on a regular basis the unit be isolated from the power supply and a vacuum cleaner used to remove dust from the inlet and outlet grilles.

Caution:

When the heater is operated ensure the heater is not obstructed in any way. Ensure the heater can operate safely, should the heater switch on when the ambient temperature drops, or a timer activates the heater.

- Do **NOT** allow the supply cord to come into contact with heated surfaces during operation.
- Regulations require that electrical work be carried out by authorised persons. For your own safety and that of others, ensure this is done.
- If the supply cord becomes damaged, it must be replaced by a qualified person, in order to avoid a hazard.

Instructions-Advise:

- **Before operating the convector, please read these instructions thoroughly to avoid damage and hazardous situations. Any use of this convector other than that stipulated in this instruction manual may cause fire, electric shock or injury, and voids all warranties.**
- Warranty does not apply to any defect, deterioration, loss, injury or damage caused by, or as a result of, the misuse or abuse of this heater. None of the terms of this warranty are to be taken as excluding any conditions or warranties implied by State law.
- Before any operation remove the packaging and check product integrity. In case of defects or damages do not try to repair it yourself but contact your dealer.
- Do not let children play with the packaging and protect the environment by disposing of the packaging in accordance with the national regulations for waste processing.

Wall mounting:

Fix the convector in horizontal position with the air outlet grill upward;

- This convector is fitted with a double electrical insulation circuit (class II) and therefore does not require earth connection.
- In wet spaces like bathrooms or kitchens, the connection terminal must be installed at least 25 cm above the floor. **figure 1 below**

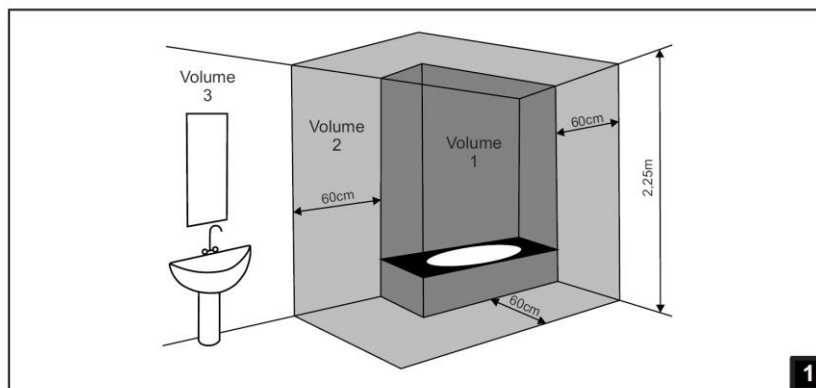

- The electrical connection to the power supply must also be fitted with a two-pole switch with a minimum gap between the contacts that allows complete disconnection according to excess voltage III category conditions.
- The device must be wall-mounted respecting the minimum distances from ceiling, floor and side walls shown in **figure 2 below**.
- The support bracket must be fixed to the wall respecting the distances indicated in **figure 3 below**
- Always observe the minimum distances from walls, furniture and/or objects, as indicated in **picture 3**.

To proceed with the installation:

- Remove the bracket from the product;
- Drill 4 holes in the wall respecting the distances indicated in **figure 3 below**

Wall mounting - cont:

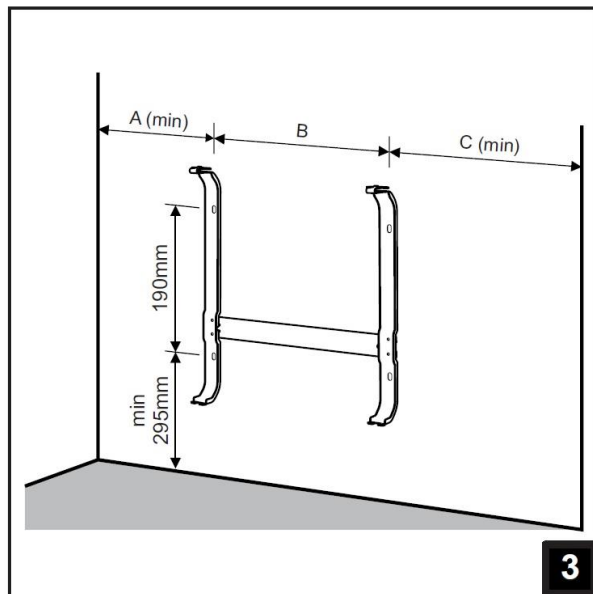
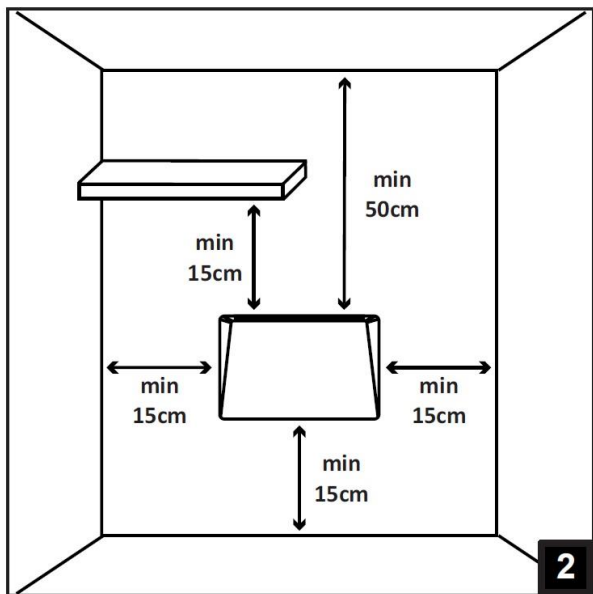

Fix the bracket using the wall plugs and screws suitable for the wall type;

-- Verify that the minimum distances previously described are satisfied;

-- Approach the product to the bracket until the lower hooks of the bracket are inserted in the slots on the rear panel as shown **in figure 4 below**;

-- Rotate the upper part of the product towards the wall until it locks, making sure to snap the 2 upper hooks of the bracket as shown **in figure 5 below**

-- Lock the 2 upper hooks of the bracket using the supplied screws as shown **in figure 6 below**.

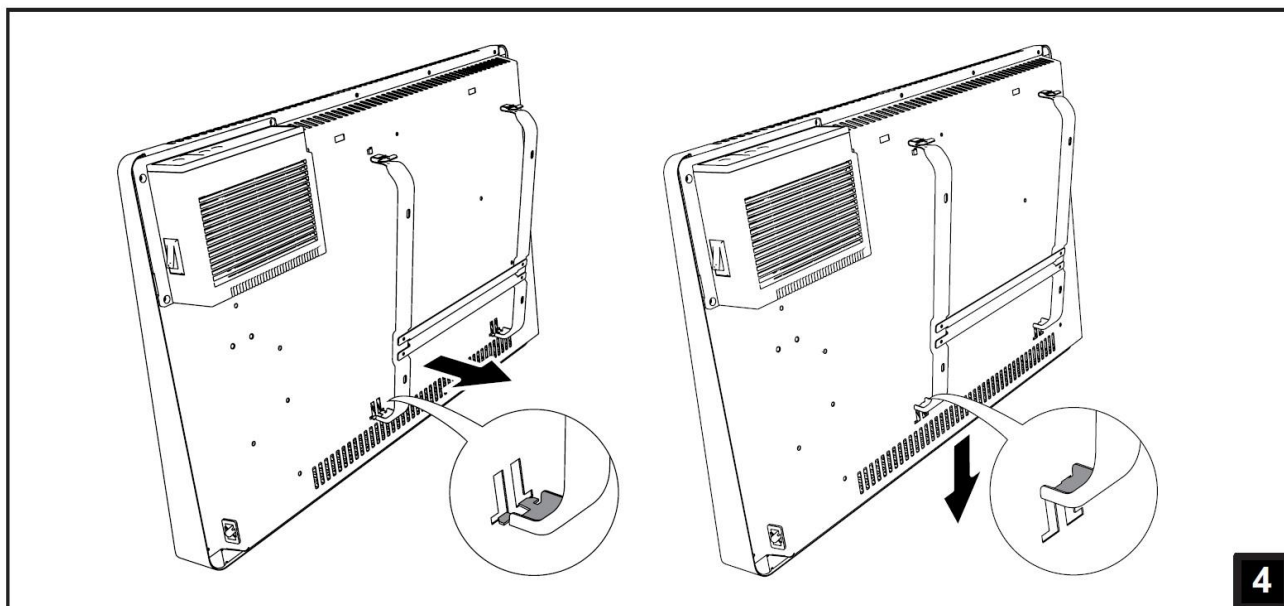

Wall mounting – cont:

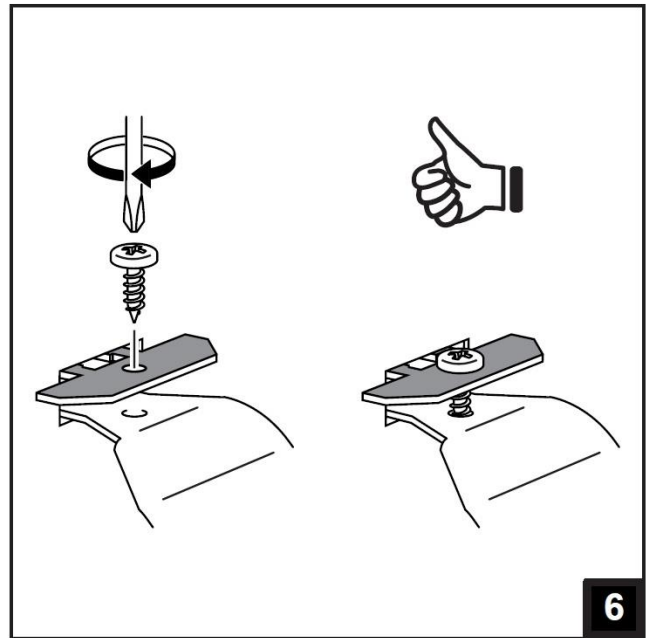
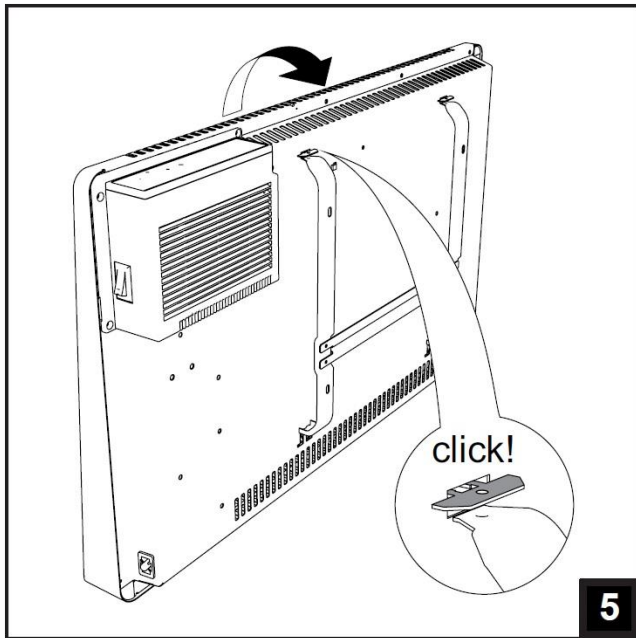

Setting-up your SIRIO Convector: Commands description



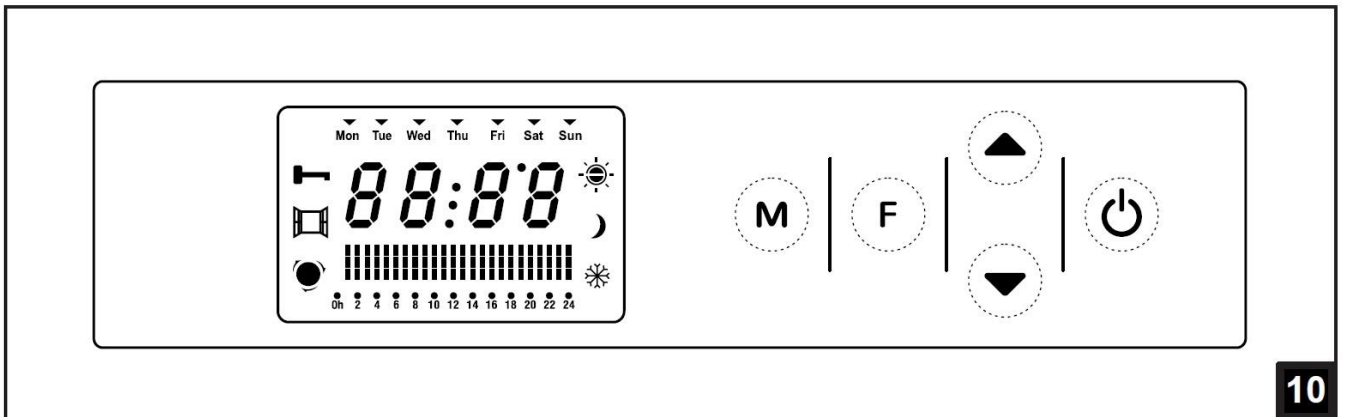



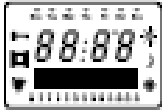

- The convector is equipped with an on / off button on the right side. When the product is switched off, the internal electrical components will no longer activated.
- The following controls are integrated on the front of the product **figure 10 below**:



Commands description:



Multi-function display to view the operation and activation status of the functions.

-  Comfort
-  Comfort - 1 °C
-  Comfort - 2°C
-  Eco
-  Anti freeze
-  Keypad lock
-  Open window detection
-  Heating in progress



Operation mode selection button.



Special functions button.



Navigation menu button.



Enable/disable stand-by mode button.

Turning on and off:

The heater is powered by an electromechanical on / off button. Switching off the product pressing this button causes the power supply to the electronic board to be interrupted and the current time and day to be cancelled.

We recommend using it only if you do not use the product for a long time and instead use the ON/STAND-BY button on the control panel in the event of a short operating interruption of the device. This way you will not lose the adjustment settings previously entered.

When switched on, the convector activates the last mode used before switching off or power failure. The time is reset at 12:00 and the day of the week on Monday.

Operating modes:

By pressing  button it is possible to select one of the following 6 operating modes:



COMFORT mode

The convector operates to reach and maintain the set comfort temperature.

The symbol corresponding to the Comfort mode lights up.
The heating symbol lights up when the heating element is operating.
In this mode, the open window detection function is available (see the FUNCTIONS button).



COMFORT mode -1

The convector operates to achieve and maintain the set comfort temperature reduced by 1° C.

The symbol corresponding to the Comfort mode lights up.
The heating symbol lights up when the heating element is operating.
In this mode, the open window detection function is available (see the FUNCTIONS button).

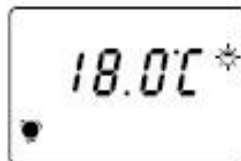

COMFORT mode -2

The convector operates to achieve and maintain the set comfort temperature reduced by 2° C.

The symbol corresponding to the Comfort mode lights up.
The heating symbol lights up when the heating element is operating.
In this mode, the open window detection function is available (see the FUNCTIONS button).

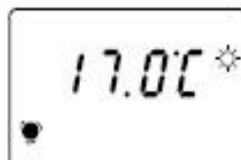

ECO mode

The convector operates to achieve and maintain the set comfort temperature reduced by 3.5° C.

The symbol corresponding to the Eco mode lights up.
The heating symbol lights up when the heating element is operating.
In this mode, the open window detection function is available (see the FUNCTIONS button).

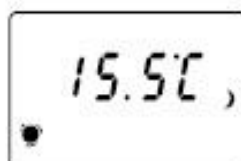

ANTI-FREEZE mode

The thermostat is automatically set at the temperature of 7 ± 3 ° C.

The symbol corresponding to the antifreeze mode lights up.
The heating symbol lights up when the heating element is operating.
In this mode the open window detection function is not available.

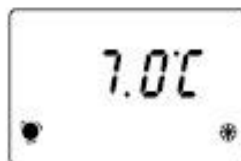

PROGRAMMED mode

The convector works to reach and maintain the temperature set in the weekly program (see the paragraph about WEEKLY PROGRAMMING).
The symbol corresponding to the operating mode (Comfort, Comfort-1, Comfort-2, Eco or Anti-freeze mode) lights up according to the settings for the current time and day.

In this mode, the open window detection function is available (see the FUNCTIONS button).



Special functions:

By pressing  button it is possible to select one of the following 3 special functions:



RESET function

By activating this function all the settings are restored to the initial factory value. The comfort temperature is set to 19.0 °C, the preset program is the one described in the appropriate section and the open window detection function is deactivated.

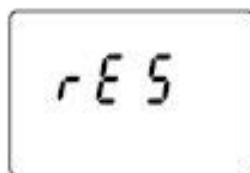

To RESET press the  button for at least 5 seconds.
The convector is automatically set in Comfort mode.



OPEN WINDOW DETECTION function

This function allows to identify the opening of a window and to automatically set the Antifreeze operation mode.



If a sharp reduction of the ambient temperature is detected during the normal operation of the product, the antifreeze mode is automatically activated to reduce energy wastes. The window symbol and the antifreeze symbol flash to indicate that the function is activated. The restoration of normal operation is not automatic but is obtained by pressing any of the 5 buttons of the product.

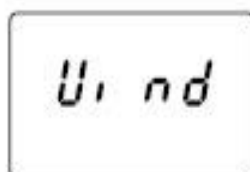

The correct functioning of this function may depend on the positioning of the product in the room, the presence of drafts, the external temperature and the window opening time.



Activate the function by pressing the  button.
The window symbol lights up on the display.

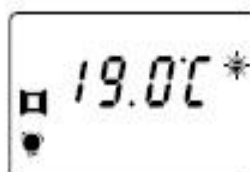

Deactivate the function by pressing the  button.
The window symbol turns off on the display.





Special functions cont:



LOCK function

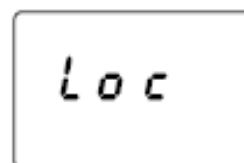

By activating this function all the keys are deactivated to prevent unwanted modifications of the operating settings.

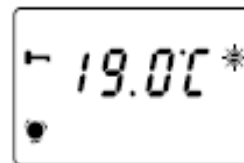

Activate the function by pressing the  button for at least 5 seconds.

The key symbol lights up on the display and the keys are locked.



Deactivate the function by pressing the  and  buttons simultaneously for at least 5 seconds.

The key symbol turns off, the buttons work again.

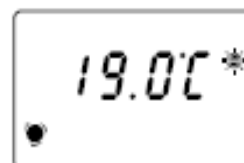

Temperature control:

- The temperature values for the Comfort-1, Comfort-2, Eco and Antifreeze modes are automatically calculated and cannot be directly modified by the user. The reference temperature is always indicated on the display together with the symbol representing the selected operating mode.
- **NOTE:** The temperature measured by the sensor inside the product always indicates the ambient temperature in the immediate vicinity of the product and may differ from the temperature measured with other instruments in other areas of the room. This difference may depend on various factors, **such as:**
 - The installation position: some areas of the room may be affected by currents or warm air pockets that can change the sensor measurement;
 - The installation on an external perimeter wall, which is normally colder than internal walls, may result in a lower temperature measurement than the actual room temperature;
 - Unstable conditions: each evaluation must be made under stable operating conditions. For this reason the Comfort temperature should not be changed before 60 minutes have elapsed since the previous modification.
 - In fact, it is not possible to assess whether the room temperature is correctly maintained by the product if the temperature level is continuously modified in a short period of time.
- **NOTE** If the difference between the set temperature and the ambient temperature is detected in stability conditions, calculate this difference and then increase or decrease the comfort temperature level on the product of the exact calculated difference value.

Date and time setting:

To set the current time and date, proceed as follows:



Keep pressing the **M** button until the programmed mode is selected.



Press the **M** button for at least 3 seconds until the day of the week starts to flash.



Use **▲** and **▼** buttons to select the current date.



Press the **M** button to switch between day setting to time setting.



Use **▲** and **▼** buttons to select the current time.



Press the **M** button to switch between hour setting and minutes setting.



Use **▲** and **▼** buttons to select the current minutes.



Press the **M** button to end the setting and return to the Programmed mode.



Weekly programming:

The weekly programming allows you to set the desired operating mode for each hour of the day and for each day of the week. The convector is supplied preset with the following weekly program:

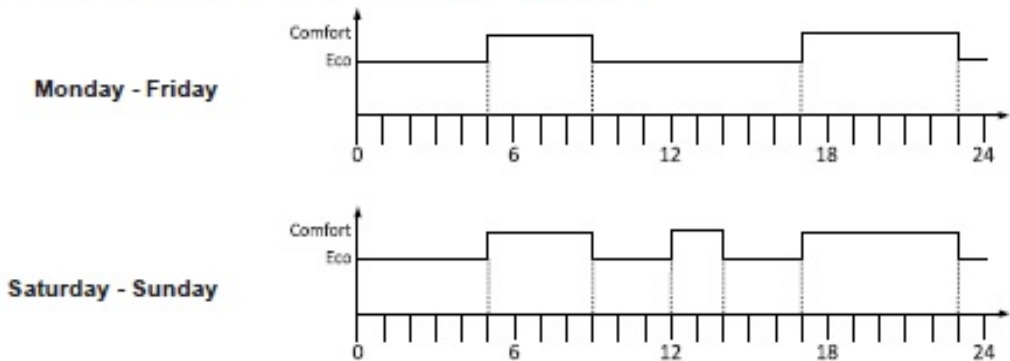

Weekly programming cont:

To view / modify the program, proceed as follows:



Press the **M** button until the Programmed operating mode is activated.



Press the **F** button for at least 3 seconds to enter the view / edit the Programming mode.
On the first day of the week, the set temperature and the corresponding symbol start to flash.



Use **▲** and **▼** buttons to select the different times of the day and the **M** button to change the operating mode of each hour.



Each time the **M** button is pressed, the operating mode changes following the sequence:



Comfort > Comfort-1 > Comfort-2 > Eco > Anti-freeze



Press the **F** button to view / edit the following day.



If you wish to copy the settings for one day to another (following), proceed as follows:



Select the day you want to copy the settings from and press **▲** and **▼** buttons at the same time.
The word "COPY" appears on the display confirming that it has been saved.



Press the **F** button to select the day you want to program with the same program you just copied.



Press **▲** and **▼** buttons together again to paste the program on the selected day. The word PROG appears on the display.



Press the **F** button to view / edit the following day.
The procedure ends by pressing the button again after viewing / editing the last day of the week. The display returns to show the programming settings for the current day and time.



Troubleshooting:

- In the event of overheating, the safety device on the appliance automatically disabled the heating elements. In this case:
 - Turn off the convector and allow it to cool down for about 15/20 minutes.
 - Eliminate any other possible reasons for overheating (e.g.: obstructions in front of the air inlet/outlet grilles, build-ups of dirt).
 - Turn on the convector again and check it works correctly.

Information for EU and UK:

Information requirements for electric local space heaters

Model identifier(s): SIRIO					
Item	Symbol	Value	Unit	Item	Unit
Heat output				Type of heat input, for electric storage local space heaters only (select one)	
Nominal heat output	P_{nom}	(*)	kW	manual heat charge control, with integrated thermostat	no
Minimum heat output (indicative)	P_{min}	(**)	kW	manual heat charge control with room and/or outdoor temperature feedback	no
Maximum continuous heat output	$P_{max,c}$	(***)	kW	electronic heat charge control with room and/or outdoor temperature feedback	no
Auxiliary electricity consumption				heat output	no
At nominal heat output	e_{max}^i	0,000	kW	Type of heat output/room temperature control (select one)	
At minimum heat output	e_{min}^i	0,000	kW	single stage heat output and no room temperature control	no
In standby mode	e_{sb}^i	0,162	W	Two or more manual stages, no room temperature control	no
				with mechanic thermostat room temperature control	no
				with electronic room temperature control	no
				electronic room temperature control plus day timer	no
				electronic room temperature control plus week timer	yes
				Other control options (multiple selections possible)	
				room temperature control, with presence detection	no
				room temperature control, with open window detection	yes
				with distance control option	no
				with adaptive start control	no
				with working time limitation	no
				with black bulb sensor	no
Contact details	Your dealer or Ermete Giudici S.p.A. - via L. da Vinci, 27 - 20090 Segrate (MI) Italy				

(*) SIRIO 5 =0,50

SIRIO 10 = 1,00

SIRIO 15 = 1,50

SIRIO 20 = 2,00

(**) SIRIO 5 =0,25

SIRIO 10 = 0,50

SIRIO 15 = 0,75

SIRIO 20 = 1,00

(***) SIRIO 5 =0,50

SIRIO 10 = 1,00

SIRIO 15 = 1,50

SIRIO 20 = 2,00

Contact

HONG KONG

t: +852 2325 3210

f: +852 2325 3166

e: info@serene-ind.com

w: www.serene-ind.com

Suite 1010, 15F, Block A, Alexander Industrial Building,
62, King Lam Street Cheung Sha Wan, Kowloon Hong
Kong

NEW ZEALAND

t: +64 (3) 344 5550

ff: 0800 437 264

e: nzenquiry@serene-ind.com

w: www.serene-ind.com

PO BOX 33501, Barrington, Christchurch 8024

AUSTRALIA

e: auenquiry@serene-ind.com

w: www.serene-ind.com

UNITED KINGDOM

t: +44 (0)1624 497794

e: ukenquiry@serene-ind.com

w: www.serene-ind.com

Rowhead House, Far Common Road
Mirfield, West Yorkshire WF140DQ