

Duratuf[®] FORTRESS SHEDS

Quality - Made Affordable

ASSEMBLY INSTRUCTIONS



TUF 50

BASE SIZE 1140mm x 1355mm



CHECK OUT OUR ASSEMBLY VIDEO

Let Keith and Justin show you how to build your Fortress shed like a professional.

When used in conjunction with these assembly instructions, Keith's practical tips and tricks will make your assembly experience that much simpler, giving you visual guidance through sections that seem tricky on paper, and help you achieve a flawless end result.

To view the video visit www.duratuf.co.nz/fortress-assembly



Note: Assembly video features a TUF400. But can be used for reference for any other Fortress model.

Duraturf

FORTRESS

ASSEMBLY INSTRUCTIONS

- Tools Required:**
- Drill
 - Drill Bit 3.5mm
 - Drill Bit 6mm (**Only required if installing an optional Clear Roof Panel**)
 - Masonry Drill and 10mm Masonry Bit (**Only required if installing a Bolt Down Kit**)
 - Riveter (free Duraturf riveter supplied in kit)
 - Hammer
 - Nail Punch
 - Tape Measure
 - Ladder or Saw stool
 - String Line
 - Hex Bit 8mm
 - Skill Saw or Jig Saw (for floor only)

IMPORTANT

SUNSCREEN WARNING: Prevent contact of the painted surface with sunscreens containing titanium dioxide (TiO₂) or zinc oxide (ZnO). It has been proven to discolour and degrade the paint finish. The use of gloves is recommended.

Damage to prepainted steel caused by contact with sunscreen is not covered by your Duraturf warranty.

Before you start:



- Read all instructions carefully.
- Identify all parts and check the quantities against checklist.
- If you are pouring your own raised concrete floor, please refer to Raised Base Plate section now to familiarise yourself with the procedure prior to starting.

Safety:

- Do not attempt to build your shed in high winds.
- Beware of sharp edges. For safety wear protective gloves—preferably rubber coated)
- Protect your eyes and ears with the appropriate safety gear
- Use electric tools with care. Use a Safety Trip Switch.
- It is easier and quicker if this shed is erected by two people.



Select your site:



- Your shed must be level. You can achieve this by either levelling and compacting the ground or by using blocks or piles to create a level platform for the shed framing to sit on.
- If your shed is to be positioned on wet or damp ground, we recommend that your shed is raised up off the ground slightly to avoid moisture and mould in the shed. A Damp Proof Course (DPC) membrane can also be used. This is available from your local hardware store.

TUF 50 PARTS LIST

COLOUR: _____ INV #: _____

ROOF SIZE: 1.175 x 1.570

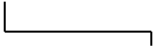
BASE SIZE: 1.140 x 1.355

QTY	LENGTH	DESCRIPTION	CHECKED OUT	CHECKED IN
3	1.890	Corner Wall Sheets	<input type="checkbox"/>	<input type="checkbox"/>
1	1.890	3/4 Corner Wall Sheet	<input type="checkbox"/>	<input type="checkbox"/>
1	1.890	Wall Sheet	<input type="checkbox"/>	<input type="checkbox"/>
2	1.570	Folded Roof Sheets	<input type="checkbox"/>	<input type="checkbox"/>
1	1.860	Door	<input type="checkbox"/>	<input type="checkbox"/>
TIMBER				
BASE PLATES				
2	1.140	Front & Back - Green 45 x 45 H4	<input type="checkbox"/>	<input type="checkbox"/>
2	1.355	Ends - Green 45 x 45 H4	<input type="checkbox"/>	<input type="checkbox"/>
TOP PLATES				
1	1.140	Back - Red 45 x 45 H1	<input type="checkbox"/>	<input type="checkbox"/>
1	1.140	Front - Red 70 x 45 H1	<input type="checkbox"/>	<input type="checkbox"/>
2	1.355	Ends - Red 45 x 45 H1	<input type="checkbox"/>	<input type="checkbox"/>
4	1.810	Studs - Yellow 45 x 45 H1	<input type="checkbox"/>	<input type="checkbox"/>
1	1.833	Studs - Blue 45 x 45 H1	<input type="checkbox"/>	<input type="checkbox"/>
2	1.265	End Wall Nogs 45 x 45 H1	<input type="checkbox"/>	<input type="checkbox"/>
1	0.106	Front Wall Nog 45 x 45 H1	<input type="checkbox"/>	<input type="checkbox"/>
1	1.050	Back Wall Nog 45 x 45 H1	<input type="checkbox"/>	<input type="checkbox"/>
FLASHINGS				
2	1.890	Door Jambs 	<input type="checkbox"/>	<input type="checkbox"/>
1	1.160	Top Plate Flashing 	<input type="checkbox"/>	<input type="checkbox"/>
1	1.170	Roof Flashing 	<input type="checkbox"/>	<input type="checkbox"/>
1		Hardware Pack	<input type="checkbox"/>	<input type="checkbox"/>
1		Duratuf Riveter	<input type="checkbox"/>	<input type="checkbox"/>
SECURITY				
2		Latches	<input type="checkbox"/>	<input type="checkbox"/>
1		Assembly Instructions	<input type="checkbox"/>	<input type="checkbox"/>
1		Touch-up Paint & Brush	<input type="checkbox"/>	<input type="checkbox"/>

PACKED BY: _____

DATE: / /

TUF 50 TIMBER FRAME

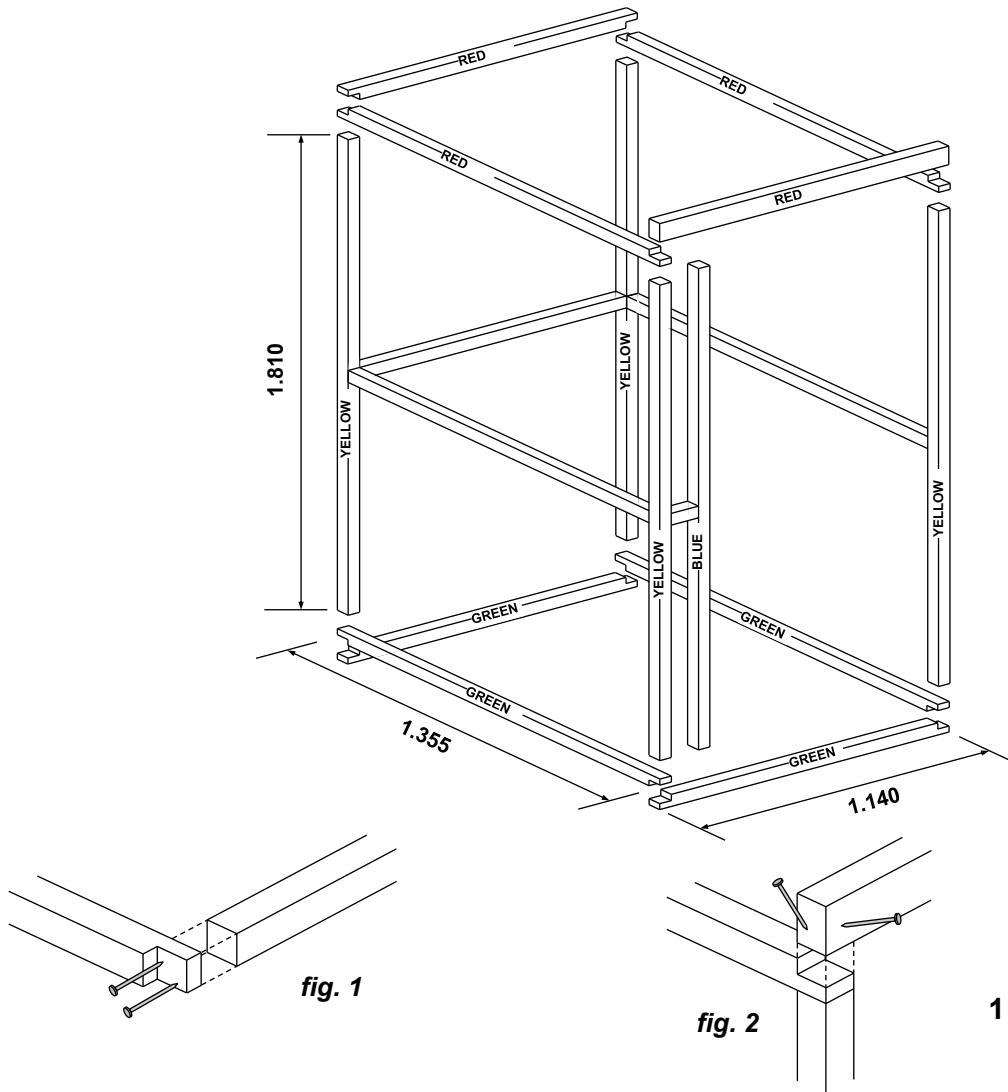

Note: For sheds being positioned on a Purpose Built Floor, shorten Studs by 30mm now (Refer to Floor Section).

Step 1: Select one End Base Plate 1.355m (Green), one End Top Plate 1.355m (Red) and two Studs (Yellow). Lay out on flat surface and nail together using two 75mm nails per joint (**fig. 1**). Repeat with the other end frame.

Step 2: Select Back and Front Base Plates 1.140m (Green), Back Top Plate 1.140m (Red) and Front Top Plate (70x45mm). With one End Frame lying on the ground, nail plates to frame, two 75mm nails per joint. Ensure Green joins to Green and Red joins to Red. See (**fig. 2**) for nailing detail on Top Front Plate (70x45mm).

Step 3: Position remaining End Frame on top of plates. While someone supports frame, nail in place using two 75mm nails per joint.

Step 4: Carefully roll frame over onto its base. Nail on Back and End Wall Nogs .882m above the top of the Bottom Plate. If fitting a Duratuf Floor, fit Floor Joist now. Evenly space joist and nail in place using three 75mm nails per end. Nail Front wall Stud (Blue) using Front Wall Nog to get correct position, Nail Front Wall Nog in centrally (this may be easier if the frame is rolled onto its Front wall).

Step 5: Fit front Top Plate Flashing centrally on Front Top Plate using four 30mm Clouts. Note - Flashing to protrude past Top Plate by 10mm each end. Position Flashing so that the widest lip is on top.

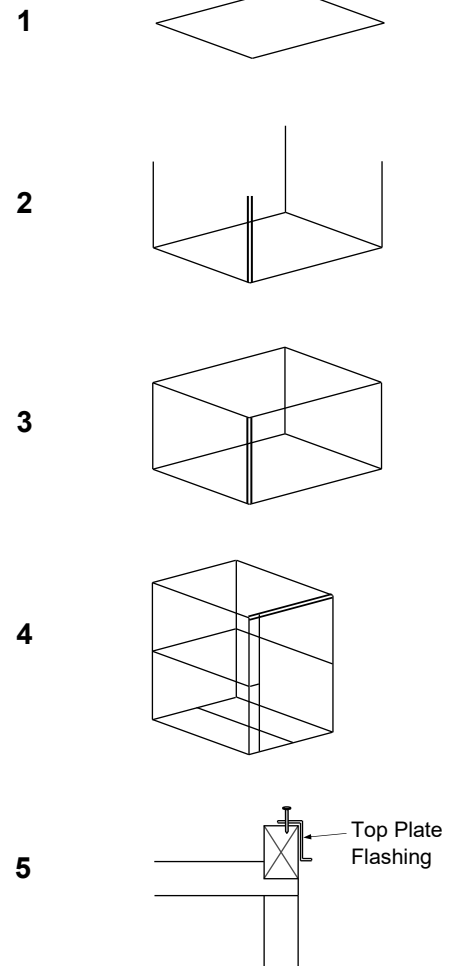

TUF 50 WALL CLADDING

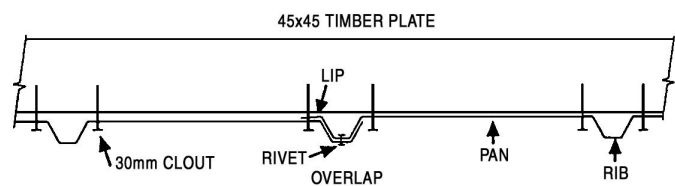
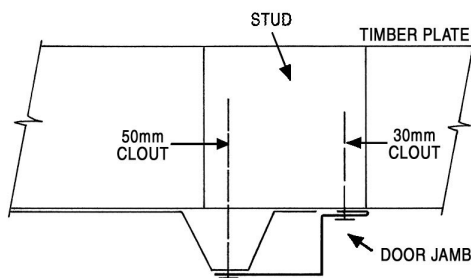
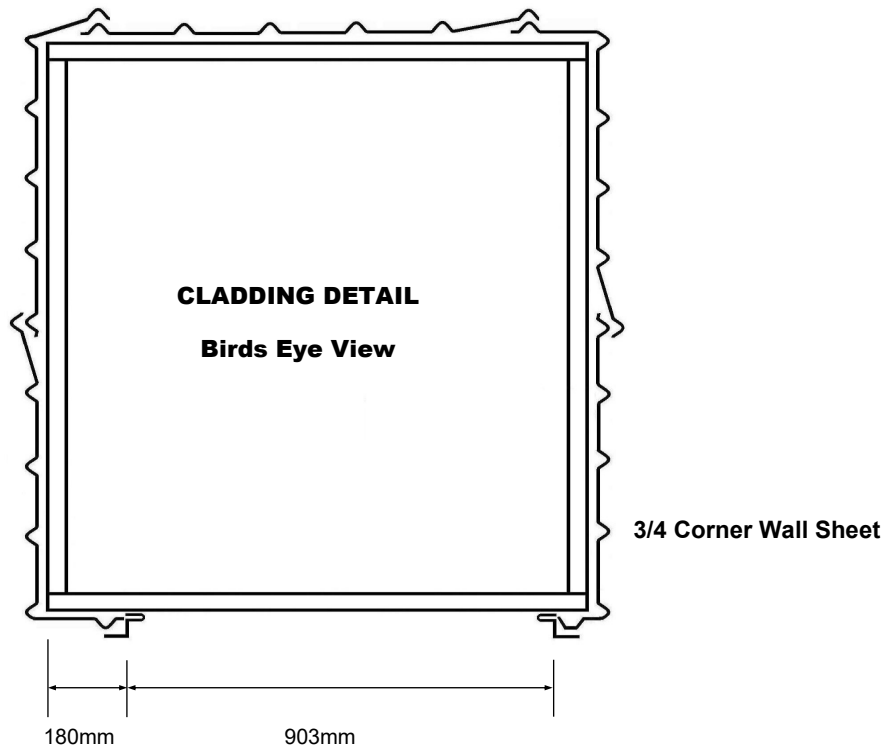

To Avoid Corrosion:

Where at all possible try not to trap metal filings between two sheets. Remove all metal filings before riveting. Carbon in pencils reacts with the Zinc/Aluminum coating on steel. Use ink to mark steel.

Step 1: Door Jambs: Position left hand Door Jamb Flashing at correct measurement from left (**cladding detail**) and nail to Top Plate using a 30mm clout. Do not fit 50mm nails at this stage. Pre-drill holes to make nailing easier (**fig. 1**).

Position Door Jamb Flashing and nail at the bottom. Position right hand Door Jamb Flashing 903mm from left hand Door Jamb Flashing (**cladding detail**) and nail in place.

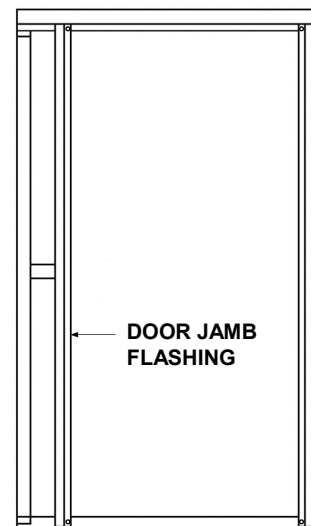

TUF 50 WALL CLADDING

Step 2: NOTE: It is very important that the Wall Sheets are positioned exactly as shown in the **cladding detail** diagram on the previous page.

Position Corner Wall Sheets. Check that the Lip is on the correct side of the sheet. While holding Corner Wall Sheet flush with the top of the Top Plate, nail to plate using only one 30mm clout top and bottom.

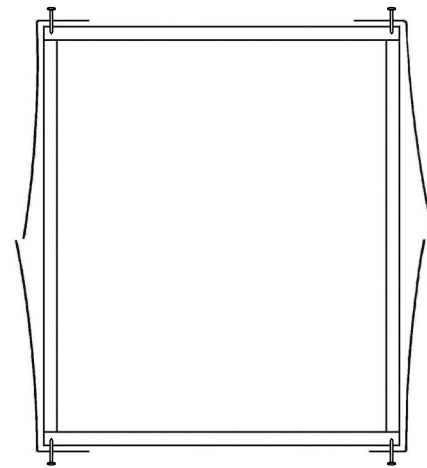

Birds Eye View

↓ = Rivet

⌋ = 30mm Clout

Step 3: Position All remaining Wall Sheets. Ensure they overlap correctly then rivet to Corner Wall Sheets, one rivet top and bottom on each overlap.

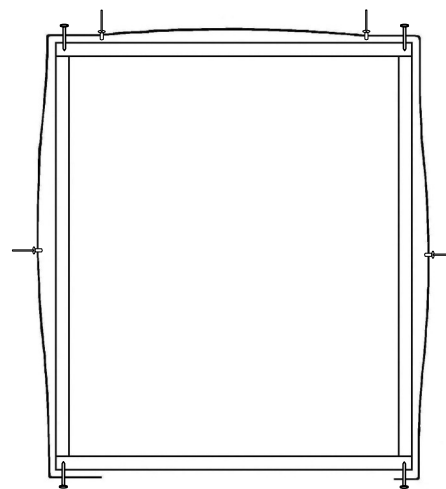

3/4 Corner Wall Sheet

Step 4: Nail Wall Sheets to Plates, two 30mm Clouts per pan top and bottom.

Nail Wall Sheets to Wall Nogs, one clout per pan.

Step 5: Drill a hole through Door Jamb Flashings and Wall Sheets top and bottom. Nail with 50mm nails (**fig. 1**).

Nail left hand Door Jamb Flashing to Stud using three 30mm Clouts at equal spacings (**fig. 1**). Beside each 30mm Clout, rivet Door Jamb Flashing to Rib. Repeat with right hand Door Jamb Flashing.



TUF 50 ROOF

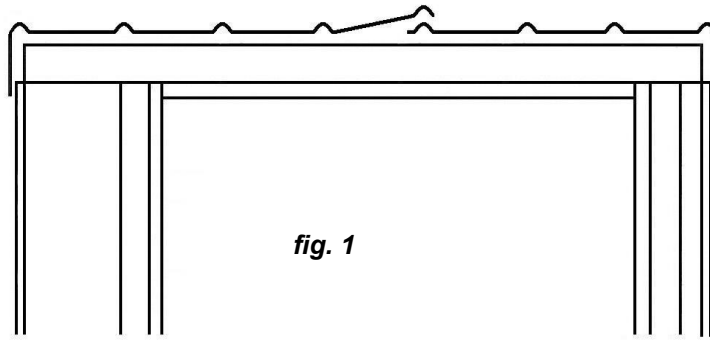

Step 1: Note: Condensation can form on the under side of shed roof. If building paper is required, fit now. Building paper will need to be supported by netting or roofing twine.

Roof: Position Roof Sheets as shown in **fig 1**. Make sure sheet joins at the back of the roof are flush. Rivet sheet joins, one rivet 200mm back from edge front and back. Fit one more rivet evenly spaced in centre of each join.

Step 2: Position Roof so that the front overhang measures 150mm. Rivet roof to wall sheets using one rivet every second Rib. Repeat at the other end ensuring overhang measures 150mm.



Step 3: Line up ribs on the roof with ribs on the walls. While someone holds the Front Plate straight, predrill using a 3.5mm drill bit and screw the roof to Top Plate using one 50mm Roofing Screw on each rib. (Outside ribs do not need to be fastened). Repeat at the back.

Note: a string line can be used to make this easier.

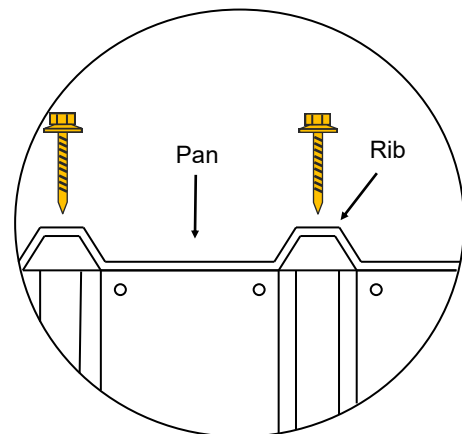

Step 4: Fit Roof Flashing as shown. When positioned correctly rivet through Roof Flashing into Roof Sheet joins.

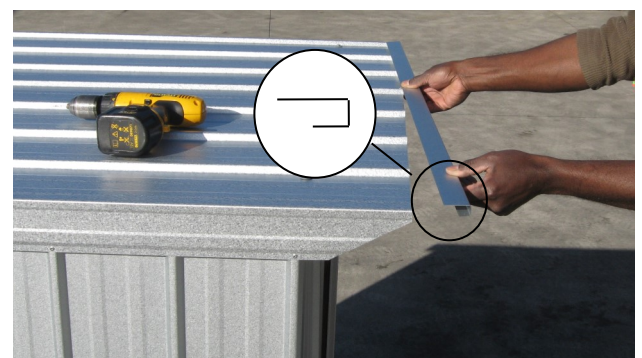

TUF 50 DOOR

NOTE: If shed has an optional security upgrade, please use Security door instructions on next page.

Step 1: Place shed in final position. Check diagonal measurements are equal and shed is level before fitting door.

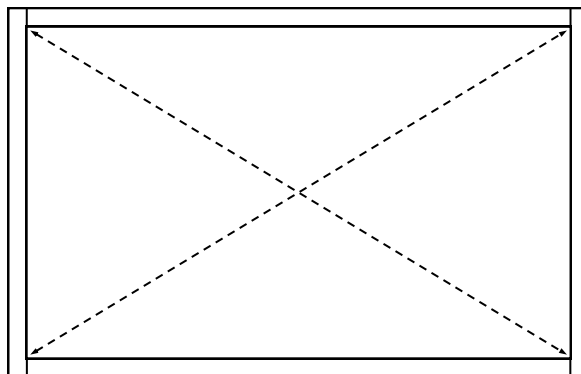

Step 2: Hold Door in position (approximately 5mm down from Top Plate Flashing) and fit one rivet to top hinge. While still holding in position fit one rivet to bottom hinge.



Step 3: Close door and check it fits correctly. If not, drill out rivets and make necessary adjustments. Fit remaining rivets to all three hinges.



TUF 50 DOOR

Step 4: Using rivets attach padbolt as shown.



FORTRESS SECURITY (Optional)

Step 1: Slide the latch on to the handle shaft. Enter shed, close door and adjust latch so it is snug with the stud at the side of the door. Tighten up bolt on latch.

Repeat for second door handle.



TUF 50 FLOOR (Optional)

Step 1: Lay a Floor Board on top of Bottom Plates and Joist and push up against Back wall. Mark out where Studs are. Cut checkouts with Jig saw so Floor Board will fit around Studs.

Repeat with Front Floor board.



Step 2: Position boards at front and back and nail in place as shown.



Step 3: Lay out remaining Floor Boards. You may need to cut the last Board to correct width using Skill saw. Nail in each Floor Board, two 50mm nails each end and two into Floor Joist.



PURPOSE BUILT FLOOR

i.e. CONCRETE / PLYWOOD

For sheds being placed on a purpose built floor, we recommend that the studs are shortened by 30mm. The Wall Sheets will then protrude 20mm below the Base Plate. This will stop water flowing in between the Base Plate and Floor.

If you choose this option, the Floor should be made 15mm smaller than Base Size.

Note: Although it is not essential, fitting Damp Proof Course in between the Base Plate and the Floor will give added protection against moisture.

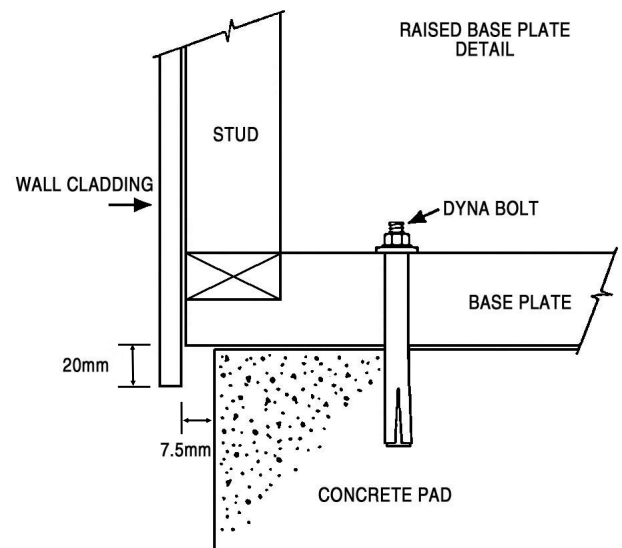

CLEAN UP

- Remove all metal filings with a soft brush or rag.
- Hose down roof and walls thoroughly.

PAINTING

- Painting Zinc/Aluminium coated steel will extend its life in most environments
- The surface must be dry and free of dirt, oil, grease and other contaminants prior to painting, but no weathering of the surface is required
- Zinc rich primers are recommended for use, along with a two coat finishing system. Paint suppliers should be consulted for the most suitable paint system to ensure compatibility of primers and topcoats.





DURATUF PREMIUM SHED WARRANTY

GUARANTEE TO CUSTOMER

Congratulations on purchasing a Duratuf Storage Shed. With proper care and attention, this product will last many years.

For your benefit **PLEASE READ THE FOLLOWING INFORMATION CAREFULLY.**

WARRANTY ON METAL CLADDING

Riverlea Group Ltd guarantee that the metal roofing and wall cladding on Kiwi and Fortress Garden Sheds may be used in moderate and inland corrosion zones or areas where the first year mild steel corrosion rate is less than 200g/m², and that in these conditions, they will not perforate due to corrosion within 30 years of date of manufacture.

TERMS AND CONDITIONS

1. Damage or corrosion due to the following circumstances is not covered by this warranty.

- ◆ Mechanical, chemical or other damage sustained during or after installation.

NOTE: Clean swarf off shed **IMMEDIATELY** after assembly

Do **NOT** mark cladding with pencil

Do **NOT** allow manures, chemicals or other corrosive materials to have direct contact with cladding

Chemical damage will result if these instructions are not carried out

- ◆ Force majeure or other causes beyond the control of Riverlea Group Ltd.

2. This warranty does not cover material installed in severe and very severe environmental situations, or in any area

WARRANTY REGISTRATION

Please visit www.duratuf.co.nz/warranty to validate the Warranty on your shed.

Click on the Warranty Registration Link and complete all details.

If you are unable to access the computer, please phone us on 0800 438 274 and one of the customer services team will help you to activate the warranty on your garden shed.



COMPLETE OUR CUSTOMER SURVEY

Thank you for investing in a Duratuf Garden Shed.

We are sure that it will provide excellent long-term storage and add value to your property. To continually improve our products and service, we would love to hear about your Duratuf experience and why you chose us.

Further to that, we would also love to see a picture or a short video of your shed installed and doing its job so that we can share this with others for their inspiration. Thank you in advance and we look forward to receiving your feedback!

To complete the survey please visit
www.duratuf.co.nz/customer-survey



**Complete the survey for your chance to
WIN a \$100 Prezzy Card!**