

ozito

PLANER

750W

INSTRUCTION MANUAL

SPECIFICATIONS

Voltage:	230-240V ~ 50Hz
Input Power:	750W
No Load Speed:	14,000/min
Planing Width:	82mm
Blade Type:	HSS Blades
Planing Depth:	3mm
Rebate Depth:	0-20mm
Weight:	3.2kg

ozito.com.au

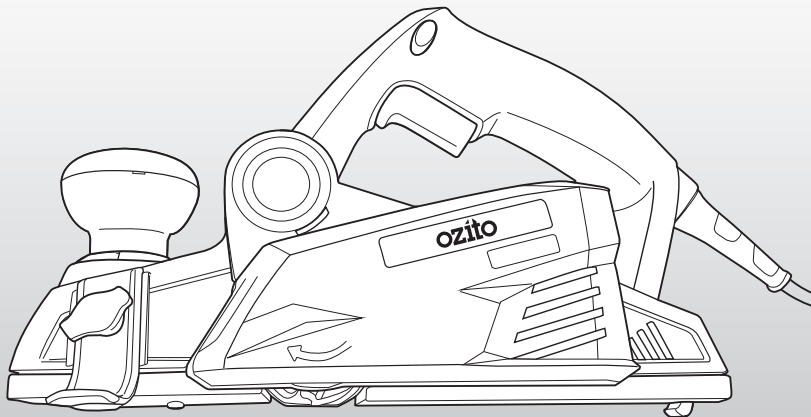

WHAT'S IN THE BOX

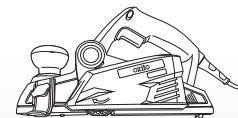

Planer

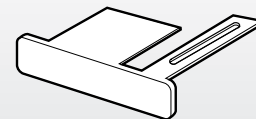

Parallel Guide

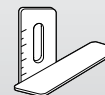

Rebate Guide



Dust Adaptor



Spanner & Hex Key

3 YEAR REPLACEMENT WARRANTY

PLR-5000

KNOW YOUR PRODUCT

PLANER

- | | |
|-------------------------|-------------------|
| 1 Depth Adjustment Knob | 5 Lock Off Button |
| 2 Guide Bracket Knob | 6 On/Off Trigger |
| 3 Dust Extraction Chute | 7 Rear Shoe |
| 4 Planing Blade | 8 Base Park Shoe |

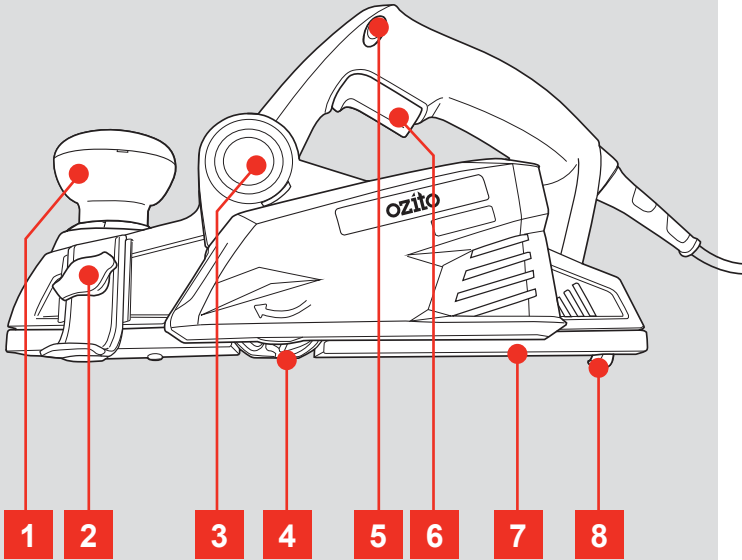

ACCESSORIES

- | | |
|------------------|--------------------|
| 9 Parallel Guide | 12 Blade Spanner |
| 10 Dust Adaptor | 13 Hex Key (2.5mm) |
| 11 Rebate Guide | |

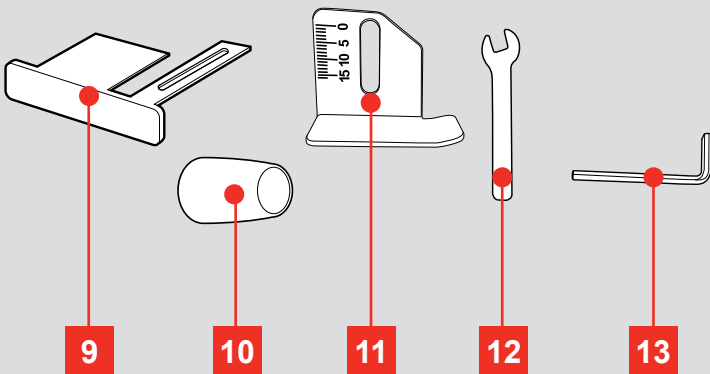

ONLINE MANUAL

Scan this QR Code with your mobile device to take you to the online manual.



SETUP & PREPARATION

1. ASSEMBLY



WARNING! ENSURE THE TOOL IS TURNED OFF AND DISCONNECTED FROM THE POWER SUPPLY BEFORE PERFORMING ANY OF THE FOLLOWING OPERATIONS.

Base Park Shoe

The park shoe allows you to rest the planer on the workpiece without the blades causing dents or damage.

The park shoe will rotate out of the way while planing.

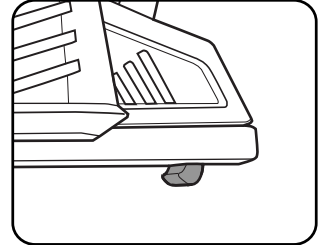

Rebate Guide

The rebate guide allows a specific rebate depth to be achieved.

- 1 Loosen the rebate guide knob by rotating it anti-clockwise.
- 2 Adjust the rebate guide to the desired depth and secure in place.

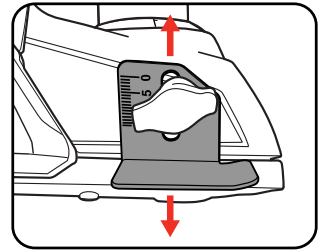
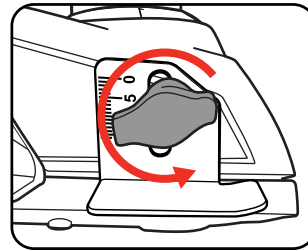

Parallel Guide

- 1 Fasten the guide mounting bracket to the parallel guide using the screw, washer and depth knob.
- 2 Align the mounting bracket with the ribs and hole on tool housing.

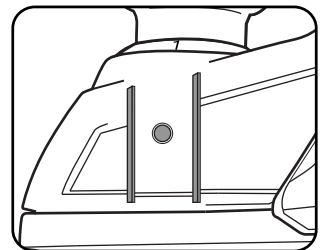
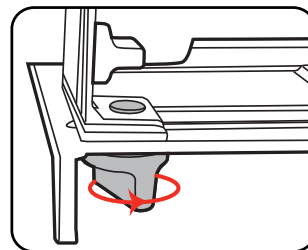

- 3 Secure the bracket and guide in place by tightening the guide bracket knob.

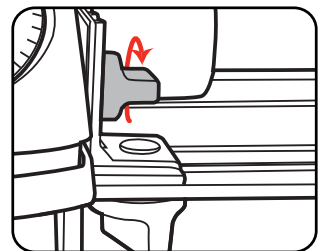

3 YEAR REPLACEMENT WARRANTY

OPERATION

2. DUST EXTRACTION

Dust Extraction Chute

The dust extraction chute can be installed on either side of the planer, allowing you to determine on which side dust extraction occurs.

- 1 To remove the dust extraction chute, rotate the chute clockwise & then slide out.

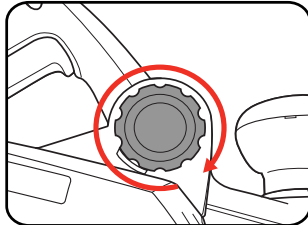

- 2 To fit the dust extraction chute, slide the chute into the opening on your preferred side.

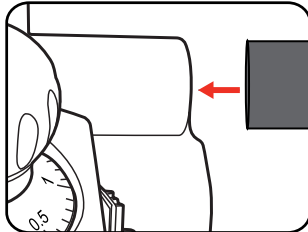

- 3 Lock in place by rotating anti-clockwise.

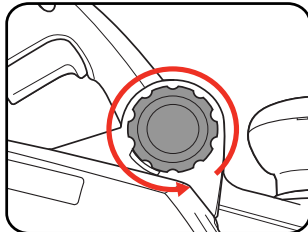

CAUTION! THE DUST EXTRACTION CHUTE MUST ALWAYS BE IN THE LOCKED POSITION WHIST OPERATING AS THIS WILL ALLOW DUST TO BE REMOVED FROM THE PLANER AND WORKPIECE.

Dust Adaptor

For optimum dust extraction, a extraction vacuum hose can be fitted to the extraction chute by using the dust adaptor. The dust extraction chute can be fitted either side of the housing to allow the hose to be connect from the desired side.

- 1 Push the dust adaptor into the dust extraction chute.

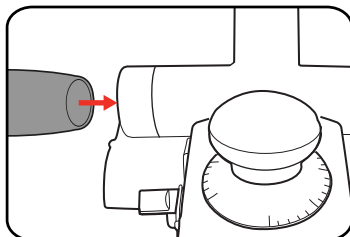

- 2 Connect a vacuum hose to the dust adaptor.

3. CONTROLS



WARNING! THE POWER SUPPLY FOR THIS PRODUCT SHOULD BE PROTECTED BY A RESIDUAL CURRENT DEVICE (RATED AT 30mA OR LESS). A RESIDUAL CURRENT DEVICE REDUCES THE RISK OF ELECTRIC SHOCK.

Lock-off Trigger

- 1 Press and hold the lock off switch.

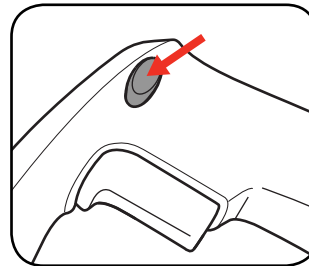

- 2 Press the on/off switch to start the planer.

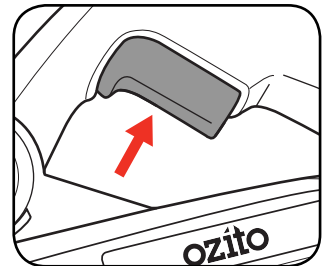

- 3 Release on/off switch to turn off.

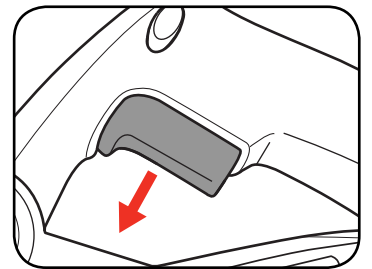

- 4 Wait until the blade stops completely before sitting the planer down.

Depth Adjustment Knob

The planing depth can be adjusted between 0 and 3mm. The numbers on the depth adjustment correspond to the planing depth (mm). Always test the setting on a scrap workpiece first.

- 1 Increase cutting depth.

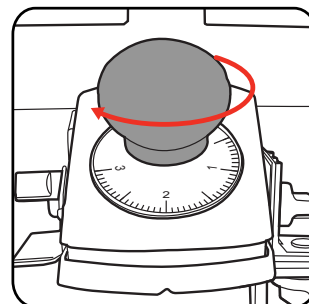

- 2 Decrease cutting depth.

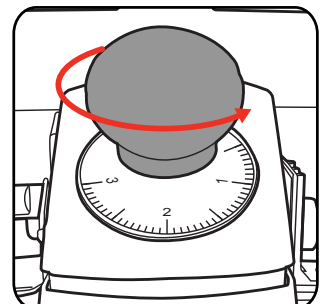

4. ADJUSTING THE PLANER

Adjusting the Rebate Guide

- 1 Loosen the rebate fixing knob.
- 2 Slide rebate bracket to the required depth.

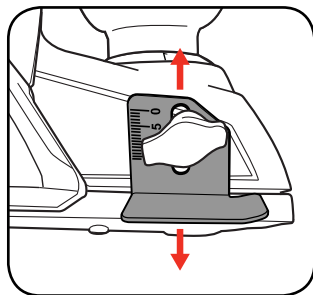
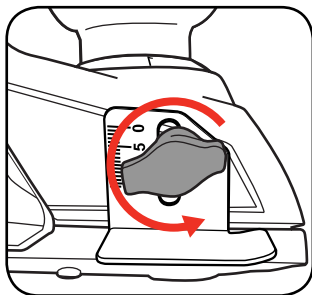

- 3 Tighten the rebate fixing knob to secure depth.

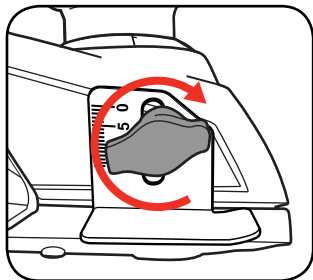

Adjusting the Parallel Guide

- 1 Loosen parallel guide knob.
- 2 Slide guide to the required position.

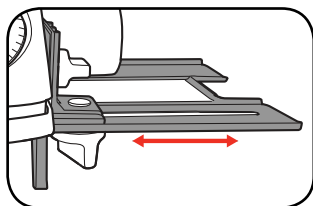
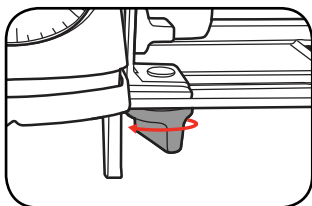

- 3 Tighten guide fence depth knob to secure position.

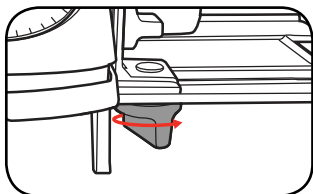

- 4 After adjusting the parallel guide, make sure the guide is clear of the blade before operating.

5. PLANING

Making a Rebate Cut

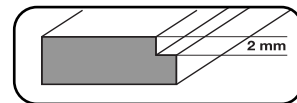

- 1 Mark out area for rebate.

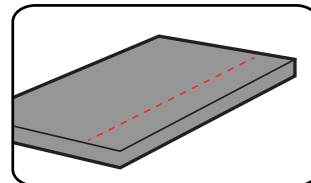

- 2 Plane along workpiece using the fence as a guide.

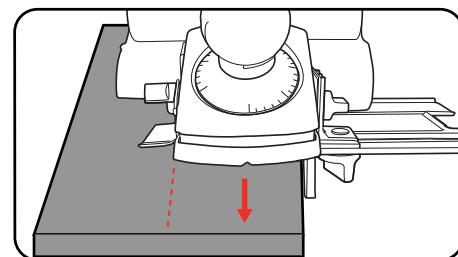

Note: It will be necessary to make a number of cuts to complete most rebates.

Chamfering

The planer has a precision machined groove in the front shoe for planing along the corner of your workpiece.

- 1 Set required depth on planer.

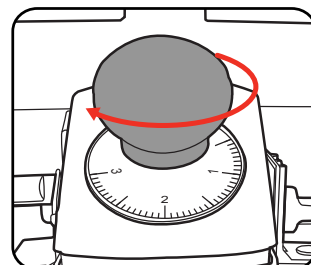

- 2 Place groove precisely on the corner of the workpiece.

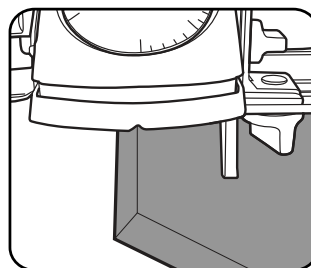

- 3 Plane along the edge of your workpiece.

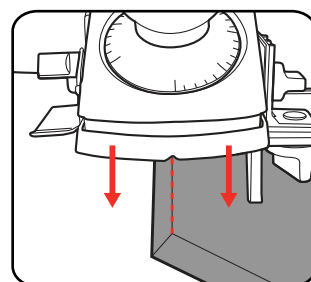

MAINTENANCE

- Keep the ventilation vents of the planer clean at all times, if possible, prevent foreign matter from entering the vents.
- After each use, blow air through the planer housing to ensure it is free from all dust particles which may build up. Build up of dust particles may cause the planer to overheat and fail.
- If the enclosure of the planer requires cleaning, do not use solvents but a moist soft cloth only. Never let any liquid get inside the planer; never immerse any part of the planer into a liquid.

Carbon Brushes

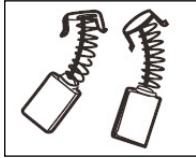

When the carbon brushes wear out, the planer will spark and/or stop. Discontinue use as soon as this happens. They should be replaced prior to recommencing use of the planer. Carbon brushes are a wearing component of the planer, and are not covered under warranty. Continuing to use the planer when carbon brushes need to be replaced may cause permanent damage to the planer. Carbon

brushes will wear out after many uses but when the carbon brushes need to be replaced, take the planer to an electrician or a power tool repairer for a quick and low cost replacement. Always replace both carbon brushes at the same time.

Note: Ozito Industries will not be responsible for any damage or injuries caused by the repair of the planer by an unauthorised person or by mishandling of the planer.

Changing Blades

Before you make any adjustments, make sure the power cord has been disconnected from the power supply.

The blades that come fitted to the tool are 82mm blades. The drum is fitted with two separate blades; both must be reversed or replaced at the same time. Never replace only one blade.

- 1 Loosen the 3 hex head screws using the spanner provided.
- 2 Push the used blade out through the slot in the motor housing using a screwdriver. **Keep fingers away from blade.**

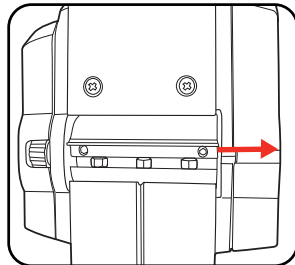
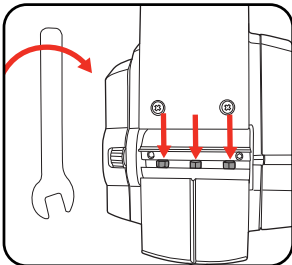

- 3 Install new blades.

Note: Blades are reversible. If changing blades for the first time, turn over the blades to expose a fresh cutting edge.

- 4 Tighten the 3 hex head screws.

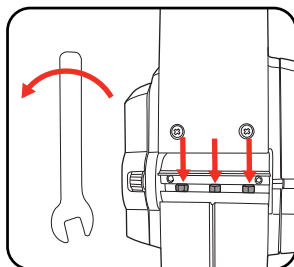

5. Repeat the process for the second blade.

TROUBLESHOOTING

Sparking visible through the housing air vents

A small amount of sparking may be visible through the housing vents. This is normal and does not indicate a problem.

Excessive sparking visible through the housing air vents and/or the planer failing to operate



May indicate the carbon brushes have worn out and need to be replaced. Carbon brushes should only be replaced by a qualified electrician or power tool repairer.

SPARE PARTS

Spare parts can be ordered from the Special Orders Desk at your local Bunnings Warehouse.

For further information, or any parts not listed here, visit www.ozito.com.au or contact Ozito Customer Service:

Australia 1800 069 486

New Zealand 0508 069 486

E-mail: enquires@ozito.com.au

DESCRIPTION OF SYMBOLS

V	Volts	Hz	Hertz
~	Alternating current	W	Watts
/min	Revolutions or reciprocation per minute	n_0	No load speed
	Read instruction manual		Warning
	Double insulated		Regulator compliance mark

CARING FOR THE ENVIRONMENT



Power tools that are no longer usable should not be disposed of with household waste but in an environmentally friendly way. Please recycle where facilities exist. Check with your local council authority for recycling advice.



Recycling packaging reduces the need for landfill and raw materials. Reuse of recycled material decreases pollution in the environment. Please recycle packaging where facilities exist. Check with your local council authority for recycling advice.

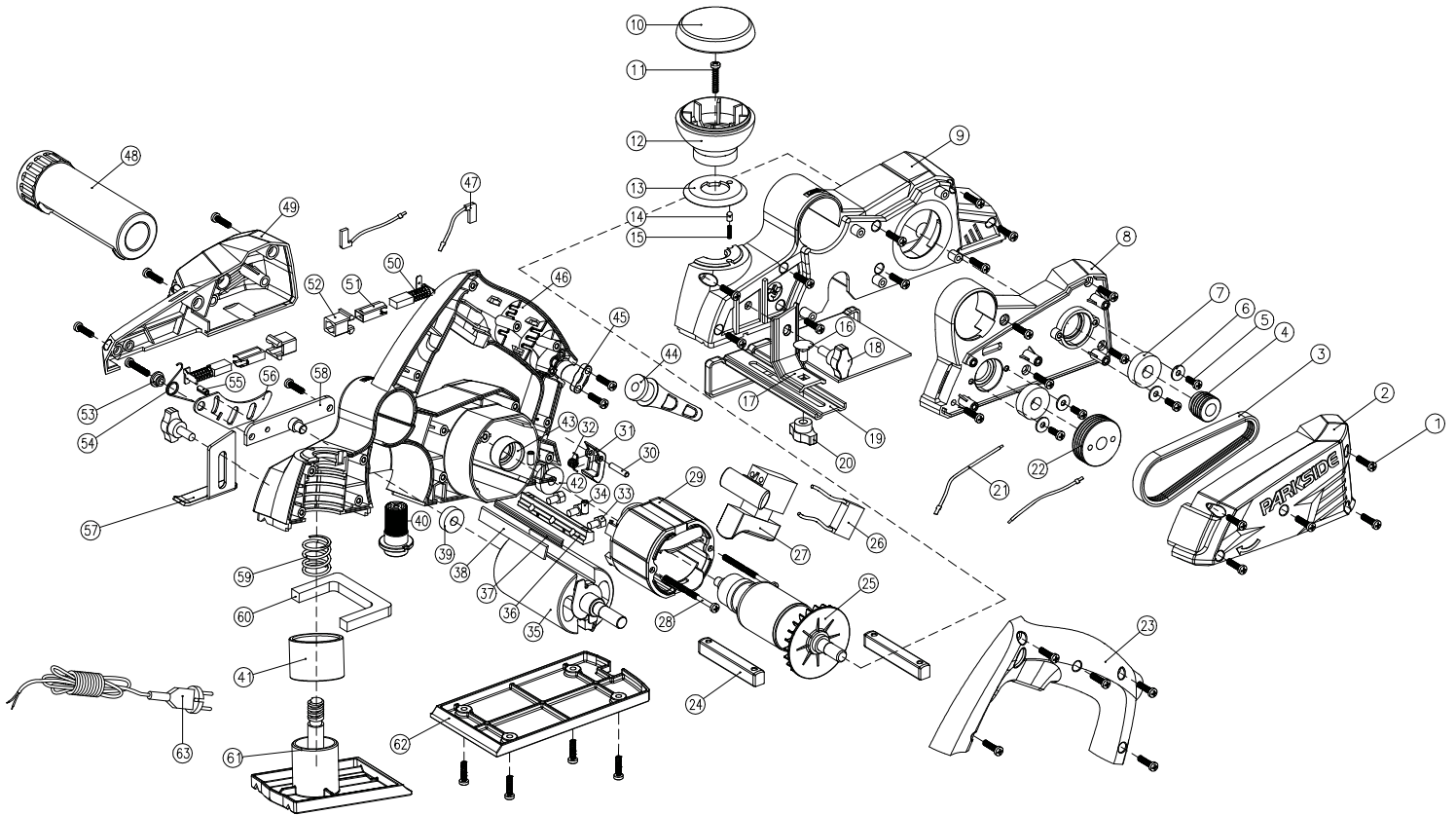

How To Order

Available spare parts can be ordered through the Special Orders Desk at any Bunnings Warehouse. If you have any further questions, please contact Ozito Customer Service on:

Australia: 1800 069 486

New Zealand: 0508 069 486

enquiries@ozito.com.au

ELECTRICAL SAFETY

 **WARNING!** When using mains-powered tools, basic safety precautions, including the following, should always be followed to reduce risk of fire, electric shock, personal injury and material damage.

Read the whole manual carefully and make sure you know how to switch the tool off in an emergency, before operating the tool.

Save these instructions and other documents supplied with this tool for future reference.

The manufacturer cannot accept any liability for damage or accidents which arise due to a failure to follow these instructions and the safety information.

This product has been designed for 230V and 240V only. Always check that the power supply corresponds to the voltage on the rating plate.

Note: The supply of 230V and 240V is interchangeable for Australia and New Zealand.



This tool is double insulated in accordance with AS/NZS 60745-1; therefore no earth wire is required.

The power supply for this product should be protected by a residual current device (rated at 30mA or less). A residual current device reduces the risk of electric shock.

If the supply cord of this power tool is damaged, it must be replaced by a specially prepared cord available through the service organization.

Note: Double insulation does not take the place of normal safety precautions when operating this tool. The insulation system is for added protection against injury resulting from a possible electrical insulation failure within the tool.

Using an Extension Lead

Always use an approved extension lead suitable for the power input of this tool. Before use, inspect the extension lead for signs of damage, wear and ageing. Replace the extension lead if damaged or defective. When using an extension lead on a reel, always unwind the lead completely. Use of an extension lead not suitable for the power input of the tool or which is damaged or defective may result in a risk of fire and electric shock.

GENERAL POWER TOOL SAFETY WARNINGS

 **WARNING!** Read all safety warnings and all instructions. Failure to follow the warnings and instructions may result in electric shock, fire and/or serious injury.

Save all warnings and instructions for future reference. The term "power tool" in the warnings refers to your mains-operated (corded) power tool or battery-operated (cordless) power tool.

1. Work area safety

- Keep work area clean and well lit. Cluttered or dark areas invite accidents.
- Do not operate power tools in explosive atmospheres, such as in the presence of flammable liquids, gases or dust. Power tools create sparks which may ignite the dust or fumes.
- Keep children and bystanders away while operating a power tool. Distractions can cause you to lose control.

2. Electrical safety

- Power tool plugs must match the outlet. Never modify the plug in any way. Do not use any adapter plugs with earthed (grounded) power tools. Unmodified plugs and matching outlets will reduce risk of electric shock.
- Avoid body contact with earthed or grounded surfaces, such as pipes, radiators, ranges and refrigerators. There is an increased risk of electric shock if your body is earthed or grounded.
- Do not expose power tools to rain or wet conditions. Water entering a power tool will increase the risk of electric shock.
- Do not abuse the cord. Never use the cord for carrying, pulling or unplugging the power tool. Keep cord away from heat, oil, sharp edges or moving parts. Damaged or entangled cords increase the risk of electric shock.
- When operating a power tool outdoors, use an extension cord suitable for outdoor use. Use of a cord suitable for outdoor use reduces the risk of electric shock.
- If operating a power tool in a damp location is unavoidable, use a residual current device (RCD) protected supply. Use of an RCD reduces the risk of electric shock.

3. Personal safety

- Stay alert, watch what you are doing and use common sense when operating a power tool. Do not use a power tool while you are tired or under the influence of drugs, alcohol or medication. A moment of inattention while operating power tools may result in serious personal injury.
- Use personal protective equipment. Always wear eye protection. Protective equipment such as dust mask, non-skid safety shoes, hard hat, or hearing protection used for appropriate conditions will reduce personal injuries.
- Prevent unintentional starting. Ensure the switch is in the off-position before connecting to power source and/or battery pack, picking up or carrying the tool. Carrying power tools with your finger on the switch or energising power tools that have the switch on invites accidents.

- Remove any adjusting key or wrench before turning the power tool on. A wrench or a key left attached to a rotating part of the power tool may result in personal injury.
 - Do not overreach. Keep proper footing and balance at all times. This enables better control of the power tool in unexpected situations.
 - Dress properly. Do not wear loose clothing or jewellery. Keep your hair, clothing and gloves away from moving parts. Loose clothes, jewellery or long hair can be caught in moving parts.
 - If devices are provided for the connection of dust extraction and collection facilities, ensure these are connected and properly used. Use of dust collection can reduce dust-related hazards.
- ## 4. Power tool use and care
- Do not force the power tool. Use the correct power tool for your application. The correct power tool will do the job better and safer at the rate for which it was designed.
 - Do not use the power tool if the switch does not turn it on and off. Any power tool that cannot be controlled with the switch is dangerous and must be repaired.
 - Disconnect the plug from the power source and/or the battery pack from the power tool before making any adjustments, changing accessories, or storing power tools. Such preventive safety measures reduce the risk of starting the power tool accidentally.
 - Store idle power tools out of the reach of children and do not allow persons unfamiliar with the power tool or these instructions to operate the power tool. Power tools are dangerous in the hands of untrained users.
 - Maintain power tools. Check for misalignment or binding of moving parts, breakage of parts and any other condition that may affect the power tool's operation. If damaged, have the power tool repaired before use. Many accidents are caused by poorly maintained power tools.
 - Keep cutting tools sharp and clean. Properly maintained cutting tools with sharp cutting edges are less likely to bind and are easier to control.
 - Use the power tool, accessories and tool bits etc. in accordance with these instructions, taking into account the working conditions and the work to be performed. Use of the power tool for operations different from those intended could result in a hazardous situation.
- ## 5. Service
- Have your power tool serviced by a qualified repair person using only identical replacement parts. This will ensure that the safety of the power tool is maintained.

PLANER SAFETY WARNINGS

 **WARNING!**

- Wait for the cutter to stop before setting the tool down. An exposed cutter may engage the surface leading to possible loss of control and serious injury.
- Hold the power tool by insulated gripping surfaces only, because the cutter may contact its own cord. Cutting a "live" wire may make exposed metal parts of the power tool "live" and could give the operator an electric shock.
- Use clamps or another practical way to secure and support the workpiece to a stable platform. Holding the work by hand or against the body leaves it unstable and may lead to loss of control.
- Recommendation that the tool always be supplied via a residual current device with a rated residual current of 30 mA or less.
- If the supply cord of this power tool is damaged, it must be replaced by a specially prepared cord available through the service organization.

 **WARNING!**

Use of this tool can generate dust containing chemicals known to cause cancer, birth defects or other reproductive harm. Use appropriate respiratory protection.

Hold power tool by insulated gripping surfaces, when performing an operation where the cutting accessory may contact hidden wiring or its own cord. Cutting accessory contacting a "live" wire may make exposed metal parts of the power tool "live" and could give the operator an electric shock.

- Be sure to read the instruction manual thoroughly before using this tool.
- Be sure the voltage agrees with specific data on the nameplate.
- Be sure the switch is in OFF position before connecting tool to the power supply.
- Be sure to switch OFF immediately if the tool is jammed in work.

- Be sure the tool is disconnected from power source when cleaning or making adjustments to the tool.
- Be sure the tool is properly held and set for correct use before turning switch to ON.
- Be sure to use specified replacement parts only.
- Be sure to maintain tool with care. Follow instructions for lubricating and changing accessories.
- Be sure to store tool in a clean dry place after disconnecting from power source.
- Keep air vents unobstructed for proper motor cooling.
- DO NOT lay tool down on shoe when the blades are exposed. This can chip the blades.
- Keep side dust extraction port unobstructed at all times.
- Never reach under the tool for any reason unless it is turned off and UNPLUGGED. BLADES ARE EXPOSED AND EXTREMELY SHARP.
- Use this tool for working with wood and wood products only.
- Never operate without securely holding the front handle.
- Always operate planer with two hands.
- Planer blades are extremely sharp – Handle with great care.

 **WARNING!**

Some wood contains preservatives such as copper chromium arsenate (CCA) which can be toxic. When sanding, drilling, or cutting these materials extra care should be taken to avoid inhalation and minimise skin contact.

This appliance is not intended for use by young or infirm persons unless supervised by a responsible person to ensure that they can use the appliance safely. Young children should be supervised to ensure that they do not play with the appliance.

WARRANTY

IN ORDER TO MAKE A CLAIM UNDER THIS WARRANTY YOU MUST RETURN THE PRODUCT TO YOUR NEAREST BUNNINGS WAREHOUSE WITH YOUR BUNNINGS REGISTER RECEIPT. PRIOR TO RETURNING YOUR PRODUCT FOR WARRANTY PLEASE TELEPHONE OUR CUSTOMER SERVICE HELPLINE:

Australia 1800 069 486

New Zealand 0508 069 486

TO ENSURE A SPEEDY RESPONSE PLEASE HAVE THE MODEL NUMBER AND DATE OF PURCHASE AVAILABLE. A CUSTOMER SERVICE REPRESENTATIVE WILL TAKE YOUR CALL AND ANSWER ANY QUESTIONS YOU MAY HAVE RELATING TO THE WARRANTY POLICY OR PROCEDURE.

The benefits provided under this warranty are in addition to other rights and remedies which are available to you at law.

Our goods come with guarantees that cannot be excluded at law. You are entitled to a replacement or refund for a major failure and for compensation for any other reasonably foreseeable loss or damage. You are also entitled to have the goods repaired or replaced if the goods fail to be of acceptable quality and the failure does not amount to a major failure.

Generally you will be responsible for all costs associated with a claim under this warranty, however, where you have suffered any additional direct loss as a result of a defective product you may be able to claim such expenses by contacting our customer service helpline above.

3 YEAR REPLACEMENT WARRANTY

Your product is guaranteed for a period of **36 months from the original date of purchase** and is intended for DIY (Do It Yourself) use only. If a product is defective it will be replaced in accordance with the terms of this warranty. Warranty excludes consumable parts, for example: carbon brushes, planer blades, etc.

WARNING

The following actions will result in the warranty being void.

- If the tool has been operated on a supply voltage other than that specified on the tool.
- If the tool shows signs of damage or defects caused by or resulting from abuse, accidents or alterations.
- Failure to perform maintenance as set out within the instruction manual.
- If the tool is disassembled or tampered with in any way.