



PREMIUM QUALITY
BATHROOMWARE

Since 1853

WHY CHOOSE HENRY BROOKS ?

Of all the rooms in your house, the bathroom is the one that most needs to be rugged and hardwearing. Even more than the kitchen, the bathroom has it tough.

It's subjected to extremes of humidity and temperature all year round and it has to cope with the entire family, every single day, often when they're rushing to get to work or to school, so doors get banged, drawers get slammed, taps get bumped or closed too hard and hairdryers get dropped – we all know how it goes. In other words, today's beautiful new bathroom can look pretty sad after just a few short years.

So the bathroom is definitely an area where quality counts, and no one knows this better than Henry Brooks & Co. We've been in the business for a long, long time, since 1853 in fact. After all those years, we're still going strong and we're still very much a 100% New Zealand owned and operated family business.

No company gets to stay in business for that long without having something unique behind them, especially in today's ultra-competitive globalised world.

For Henry Brooks & Co, it comes down to three things:

1. The very best quality products
2. Superb customer service
3. Specialisation





THE VERY BEST QUALITY PRODUCTS

Quality always matters but it never matters more than when you're dealing with a difficult environment like a bathroom. So we source and manufacture products that are designed to last. We won't compromise on quality. We never have and we never will. However, we're still very aware of price versus performance, so we're always aiming to offer the best value for money in New Zealand.

Our experienced team carefully considers every aspect of all of our products before we offer it to the market. If there's something we're not happy with, then it gets sorted out long before it gets to our showrooms, let alone to our customers. This means that our products last and that bathrooms designed around our products look better for longer. They'll look great too because we're very aware of modern tastes and design trends. Frankly, if we wouldn't put it in our own homes, then we won't sell it. End of story.



SUPERB CUSTOMER SERVICE

Our customers are the lifeblood of our company and their peace of mind is vitally important to us. Without them, we simply don't have a business, so we look after them. We work closely with our showroom staff and retail partners to ensure that our customers get exactly what they want and need, and if there's a problem, any problem, we'll sort it out. Every time.



SPECIALISATION

All we do is bathrooms – we're a specialist supplier of bathroom fittings, materials and products and nothing else, so we're not distracted with any other manufacturing or retail concerns. After being in business for so long, we know our stuff and we know it well, which means you can be assured that you're dealing with the experts.



MANUFACTURING

Product design and specifications are done right here in New Zealand for New Zealand conditions and New Zealand tastes.

Products are manufactured in world class manufacturing facilities, using only the finest of materials and best work place practices available.



DISTRIBUTION

The Henry Brooks range of products are either manufactured or imported to our Auckland or Wellington Factory/Distribution centres. From our extensive stock holdings, we aim to satisfy customer orders within 48/72 hours to all corners of the country.

Henry Brooks & Co aim to keep 3 month's stock on hand at any one time and targets 90% customer order dispatch within 24 hours of order receipt.



SERVICING AND PARTS

Henry Brooks & Co prides itself on the level of spare parts we carry to support the products we sell.

We have authorised service/installation technicians throughout New Zealand who look after any servicing issues with our products.



vanities

STYLISH DRAW HANDLES



Strata Woodgrain
Interchangeable
Drawer Panels

QUALITY FINISH



MODERN DESIGN



AVAILABLE SIZES

	Size	Drawers/Basins
Strata Quad 1200	1200w x 465d x 520h	4 Drawers Single Vitreous China Basin
Strata Quad 1500	1500w x 465d x 550h	4 Drawers Single Large Polymarble Basin



Scan this QR code for more information on the Strata Quad

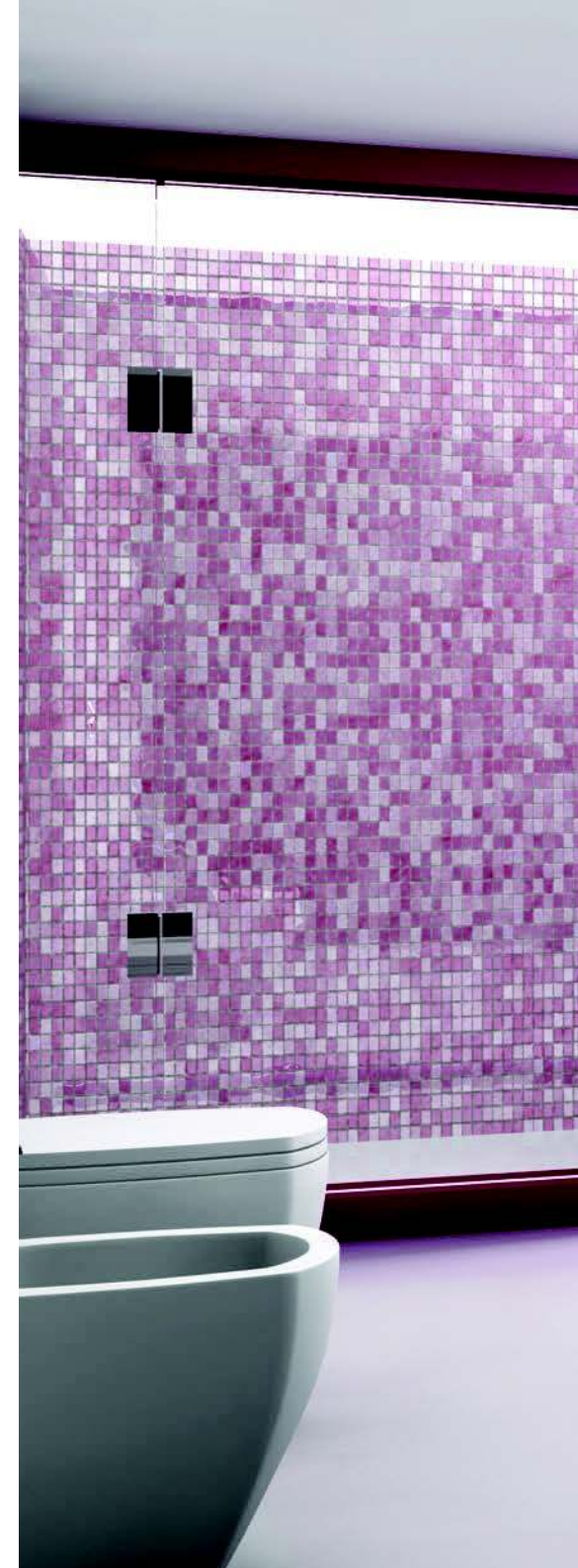
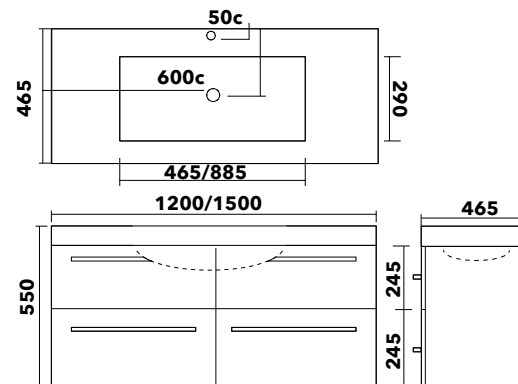

strata quad

The Strata Quad four drawer vanities are ideal for the larger bathroom. With their large single basin, they offer plenty of space on those busy mornings and with four large drawers, there's enough storage for the whole family.



FEATURES

- Available with a small square China bowl or a large rectangular Polymarble bowl
- Four big drawers offer a massive amount of storage
- Fitted with rugged, over specified hardware
- Woodgrain interchangeable drawer front panels
- Soft-close mechanisms on drawers

STYLISH DRAW HANDLES



SOLID CONSTRUCTION



VITREOUS CHINA TOP



strata duo

The Strata range features a cutting edge ultra clean look and with the Woodgrain interchangeable drawer front panels, they can be customised to fit in with your bathroom's colour scheme. The wall hanging design allows for more floor area to be visible in your bathroom, which helps to create the illusion of space.

Like all Henry Brooks products, the Strata vanities are manufactured to our exacting specifications, constructed with highly resinated water-resistant MDF, and are finished with a hardwearing lacquered white paint, so they're ready for years of use by your family.

FEATURES

- The double drawers offer a huge amount of storage space
- Ultra modern bar handles
- Woodgrain interchangeable drawer front panels
- Soft-close mechanisms on drawers



Strata Woodgrain Interchangeable Drawer Panels

AVAILABLE SIZES

	Size	Drawers
Strata Duo 600	600w x 465d x 520h	Two
Strata Duo 750	750w x 465d x 520h	Two
Strata Duo 900	900w x 465d x 520h	Two



Scan this QR code for more information on the Strata Duo

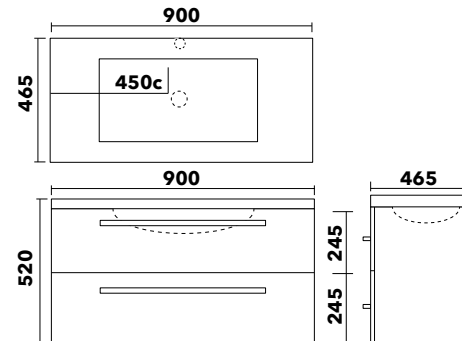



POLYMARBLE DOUBLE BOWL BASIN



CONSTRUCTION AND HARDWARE



POLYMARBLE SINGLE BOWL BASIN



chloe

With a simple modern design and affordable value that is easy to clean, our Chloe range offers a stylish vanity that will fit almost any area.

The wall hanging design allows for more floor area to be visible in your bathroom, which helps to create the illusion of space inside your ensuite or smaller bathroom.

Like all Henry Brooks products, the Chloe vanities are manufactured to our exacting specifications, constructed with highly resinated water-resistant MDF, and are finished with a hardwearing lacquered white paint, so they're ready for years of use by your family.

FEATURES

- Polymer marble vanity top with shaped basin and overflow
- Sturdy cabinet with protective white Hi-Gloss lacquer paint finish ensures no seams for a moisture-proof vanity
- 16mm thick backboard for a secure fixture to the wall
- Metal sided drawers with soft close runners

AVAILABLE SIZES

	Size	Drawers/Basins
Chloe 1050	1050w x 490d x 520h	2 Drawers Single Bowl Basin
Chloe 1200	1200w x 500d x 520h	2 Drawers Double Bowl Basin



Scan this QR code for more information on the Chloe

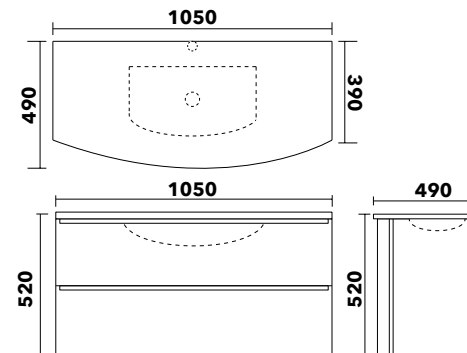



2 POT WHITE LACQUER FINISH



VITREOUS CHINA TOP



ADJUSTABLE SHELVING



albion

The Albion Floor Model range is designed to fit in with any modern bathroom décor, and our wide range of types and sizes means that we have a vanity that will fit almost any area.

Like all Henry Brooks products, these vanities are manufactured to our exact specifications, constructed with highly resinated water-resistant MDF, and are finished with a hardwearing lacquered white paint, so you know that they'll look like new for ages.

FEATURES

- Available with square or oval basins to suit your style
- Plenty of easily accessible storage with adjustable shelves
- Hardwearing seamless lacquered white paint finish
- Fitted with rugged, quick release hinges
- Soft-close mechanisms on drawers

AVAILABLE SIZES

	Size	Doors	Drawers
Albion 500FS	500w x 250d x 850h	2	None
Albion 600FS	600w x 460d x 850h	2	None
Albion 750FS	750w x 460d x 850h	1	2
Albion 900FS	900w x 460d x 850h	1	2
Albion 1200FS	1200w x 460d x 850h	1	4



Scan this QR code for more information on the Albion

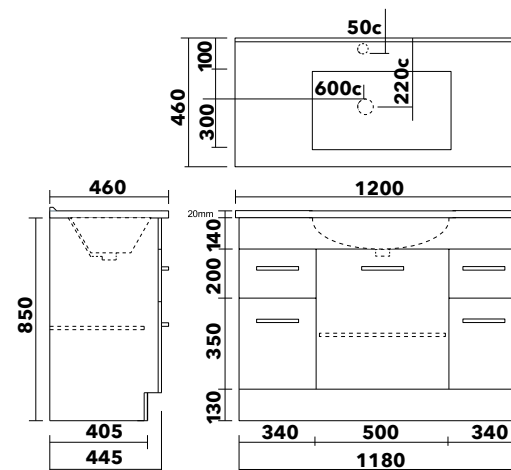



HANDLE FEATURE DETAIL



HIGH STORAGE



flash

The Flash vanity range offers a simple modern design, that delivers fantastic value for money with lots of storage space. The Flash vanity is no deeper than 400mm which makes it very easy to clean. Our designers have incorporated the handle into the front of the vanity which saves space and stops the handle protruding past the front of the cabinet, making the Flash perfect for smaller bathrooms.

The 2 available sizes of the Flash vanity ensure that we have a vanity that will make the most of storage in any small bathroom. The wall hung option allows for more floor area to be visible, helping to create a vision of space inside your ensuite or smaller bathroom.

FEATURES

- Polymarble top with modern oval basin and overflow
- Sturdy cabinet with protective white Hi-Gloss lacquer paint finish ensures no seams for a moisture-proof vanity
- 16mm thick backboard for a secure fixture to the wall
- Metal sided drawer with soft close runners
- Handle incorporated into the drawer front with the option to change the feature trim colour.

Flash trim colours:

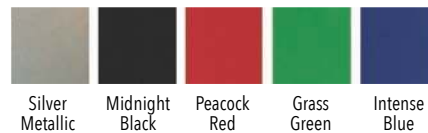

AVAILABLE SIZES

	Size	Drawers
Flash 600	600w x 400d x 500h	One
Flash 800	800w x 400d x 500h	One



Scan this QR code for more information on the Flash

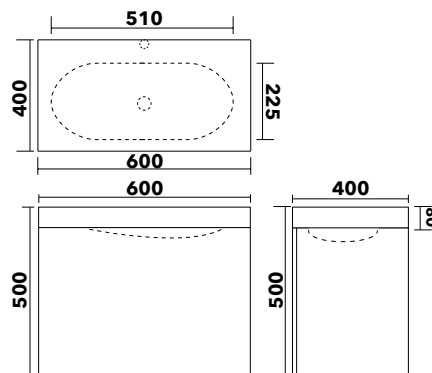

storage tall towers and mirrored wall cabinets

flash

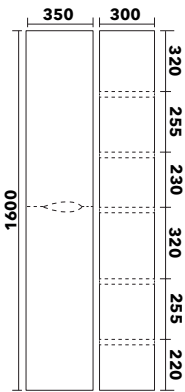

The Flash Tall Tower is a single tower unit, but with twin doors which are reversible. The Flash Tall Tower obviously compliments the two Flash vanities available on the previous page.

The feature of the recessed handle pull, allows for customization by incorporating a "flash" of colour to compliment your bathroom decor or accessories. Standard trim colours are available from us or alternatively you can personalise with your own colour choice.

strata

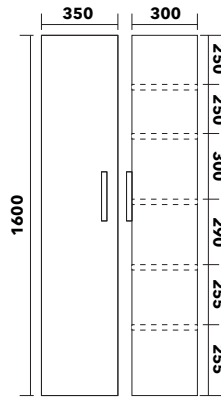

The Strata Tall Tower is a very popular addition to any bathroom, and provides an enormous amount of extra storage, while also looking stylish at the same time. The cabinet is constructed from highly resinated MDF, which is water resistant, and then painted with 4 coats of polyurethane enamel paint, to give it a high lustre finish.



Strata Woodgrain Interchangeable Door Panels

albion

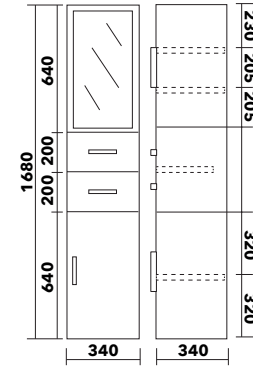

The Albion Tall Tower is a hugely popular addition to any bathroom, and provides an enormous amount of extra storage without taking up much floor space. The stylish design means that it will effortlessly complement the décor in your bathroom. Available with and without legs.

mirrored wall cabinets



These elegant and functional mirrored wall cabinets offer extra space in your bathroom and can be recessed into the wall cavity if desired. The 600 and 750 cabinets doors open outwards to give easy access to all stored items. Glass shelves and soft close cupboard doors make this a classy edition to any bathroom design.

strata slimline toilet storage



This stylish but compact toilet vanity comes in a white lacquer paint finish, or it can be optioned with any of the Strata interchangeable woodgrain door front options. The basin is reversible as is the door front.



Strata Woodgrain Interchangeable Door Panels

AVAILABLE SIZES

	Doors	Features
600	Two	The 600 cabinet doors open outwards to give easy access to all stored items
750	Two	The 750 cabinet doors open outwards to give easy access to all stored items
900	Three	The 900 cabinet outer doors open inwards so that ladies' hair and make up can be inspected from different angles
1050	Three	The 1050 cabinet outer doors open inwards so that ladies' hair and make up can be inspected from different angles

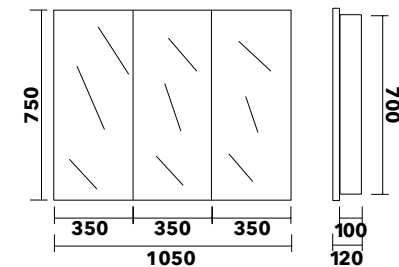

shower

PIVOTING DOOR



STYLISH DOOR HANDLE



ACRYLIC TRAY AND 40MM UPSTAND



AVAILABLE SIZES

Size	Door	Lining
900 x 760	Chrome or White	Flat or Moulded
900 x 900	Chrome or White	Flat or Moulded
1000 x 1000	Chrome or White	Flat or Moulded
1200 x 900	Chrome or White	Flat or Moulded

FEATURES

- Pivoting 6mm toughened safety glass door, which is manufactured and tested to comply with strict New Zealand safety standards
- Door frame constructed from rugged aluminium
- Reversible for left-hand or right-hand installation
- Chrome hinges and fixing points
- Easy to clean finish



Scan this QR code for more information on the Two Sided Corner Showers





two sided corner shower

Our Two Sided Corner Shower range is available in a wide range of sizes to suit any shape or size of bathroom. They can be placed in the perfect corner position to suit the layout of your bathroom and to maximise space. Like all Henry Brooks products, these showers

are manufactured to our exacting specifications, and constructed and finished with rugged hardwearing materials, so you know that they'll look like new for ages. They're practical, watertight, easy to install and have a full five-year warranty.

UNIQUE DESIGN



QUALITY CONSTRUCTION



DURABLE AND HARDWEARING FINISH



collesium

The stylish Collesium Curved Front Showers are perfect for the modern bathroom. Their curved front lends an air of elegance to the room while maximising the available space.

Like all Henry Brooks products, these showers are manufactured to our exacting specifications, and constructed and finished with rugged hardwearing materials, so you know that they'll look like new for ages. They're practical, watertight, easy to install and have a full five-year warranty.

AVAILABLE SIZES

Size	Door	Lining
900 x 900	Chrome or White	Flat or Moulded
1000 x 1000	Chrome or White	Flat or Moulded



Scan this QR code for more information on the Collesium

FEATURES

- Magnetic door seal keeps water inside your shower where it belongs
- Doorframe constructed from rugged aluminium
- Durable and hardwearing finish in white powdercoat or tough chrome finish
- Made of hygienic one-piece sanitary grade acrylic with no corner joins or seams
- Totally watertight seal and tested to drain 40 litres of water per minute





SPACE SAVING



STYLISH DOOR HANDLE

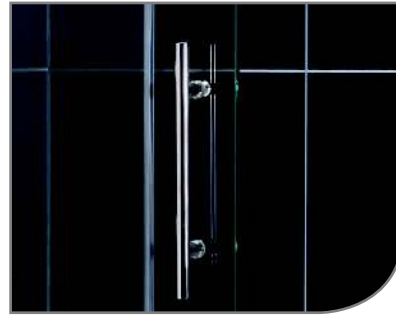

ACRYLIC TRAY AND UPSTAND



dreamline urban

Dreamline shower doors are frameless, functional and stylish. They are well engineered with simple clean lines and a solid wheel mechanism providing a smooth gliding motion. Dreamline showers are a practical solution for when space is limited, and are suitable in alcove or 2 sided tiled showers.

Like all Henry Brooks products, these showers are manufactured to our exacting specifications, and constructed and finished with rugged hardwearing materials, so you know that they'll look like new for ages. They're practical, watertight, easy to install and have a full five-year warranty.

These enclosures feature sliding frameless glass and stainless steel door rollers to suit openings from 1400mm to 1800mm wide.

Overall height is 2000mm.



Scan this QR code for more information on the Dreamline

FEATURES

- 8mm toughened safety glass door, which is manufactured and tested to comply with strict New Zealand safety standards
- Frameless, functional and stylish
- Easy to clean finish
- Easily adjustable for the perfect installation
- Durable and hardwearing polished aluminium or 316 stainless steel extrusions and components



shower tray specifications

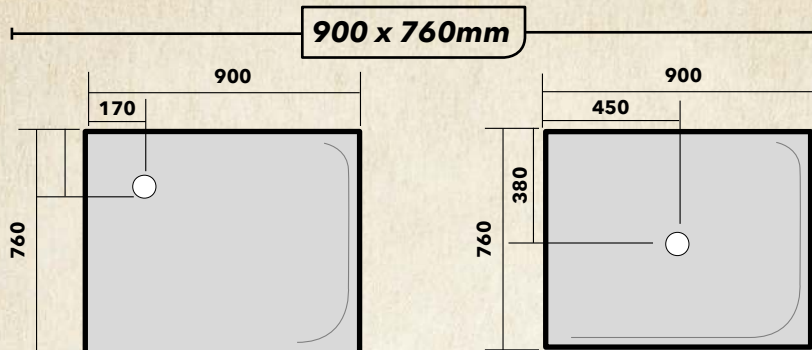

STF39076
3 Sided Alcove
Freeflow Corner Waste

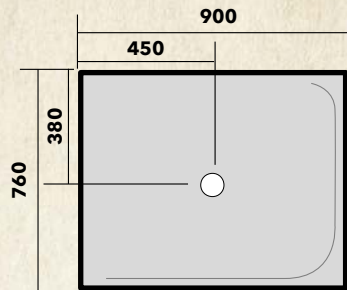

STF49076
Centre Waste - 4 Lip tray
Suit either 3 Sided Alcove or 2 Sided Corner

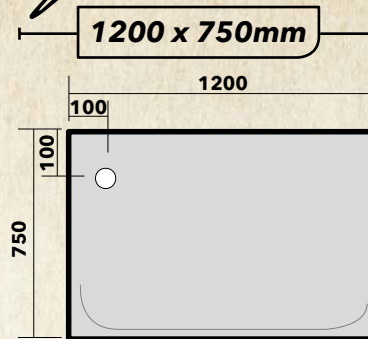

STF41275
Left rear/right front waste, 4 Lip tray - suit either
3 Sided Alcove or 2 Sided Corner

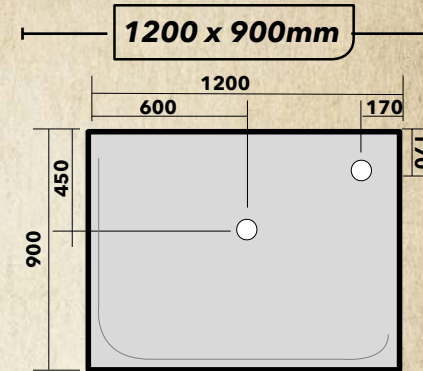

STF41290
Rear right waste - 4 Lip tray
ST41290
Centre Waste - 4 Lip Tray Suit either 3 Sided
Alcove or 2 Sided Corner

900 x 900mm

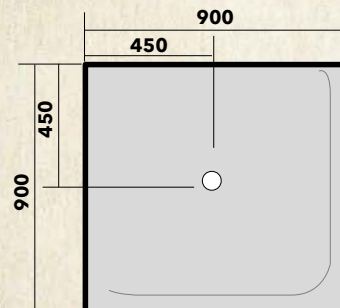

ST29090
2 Sided Corner Centre Waste

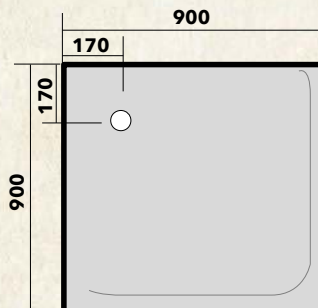

STF29090
2 Sided Corner Freeflow Corner Waste

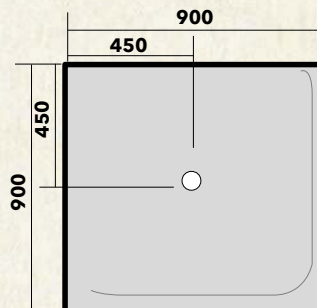

ST39090
3 Sided Alcove Centre Waste

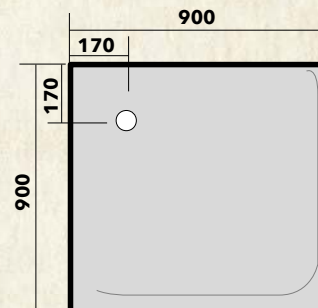

STF39090
3 Sided Alcove Freeflow Corner Waste -
Left Rear Position only

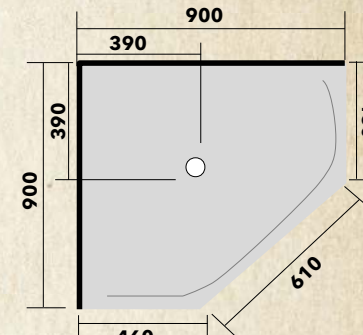

ST4529090
Angle Corner - Centre Waste

Collesium Curved

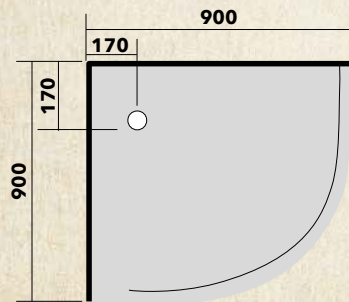

STC9090
Freeflow Corner Waste ONLY

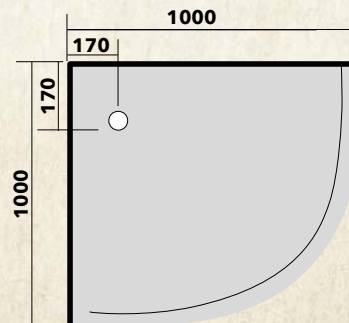

STC1010
Freeflow Corner Waste ONLY

Collesium Rapid Curved

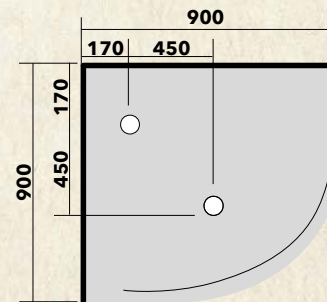

STRR9090 **STRC9090**
Rear Corner Waste Centre Waste

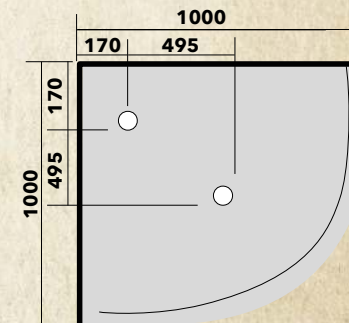

STRR1010 **STRC1010**
Rear Corner Waste Centre Waste

Dreamline Urban Shower Trays - 2 Sided

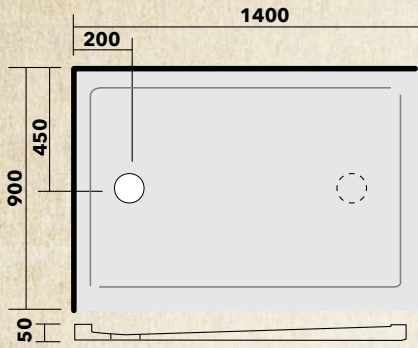

ST1490
2 Sided Left hand/Right hand centre waste

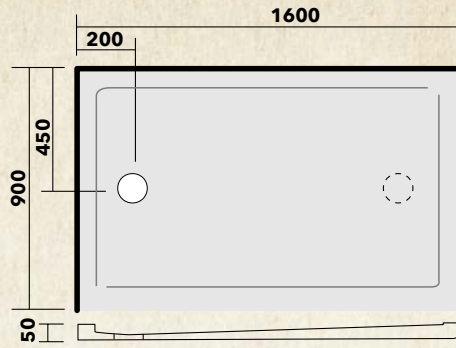

ST1690
2 Sided Left hand/Right hand centre waste

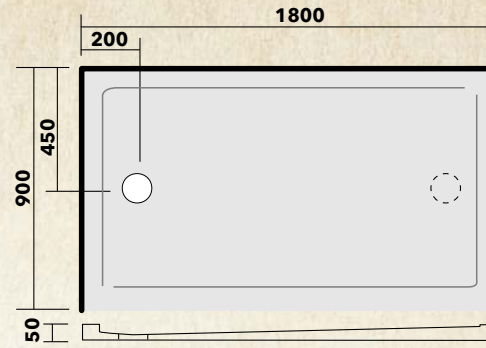

ST1890
2 Sided Left hand/Right hand centre waste

Dreamline Urban Shower Trays - 3 Sided

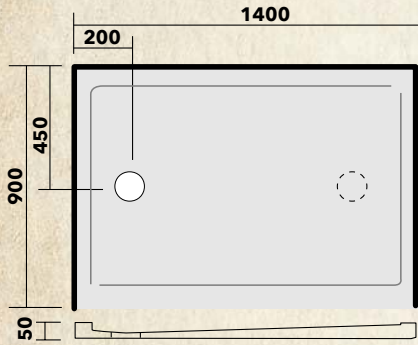

ST1490
3 Sided Left hand/Right hand centre waste

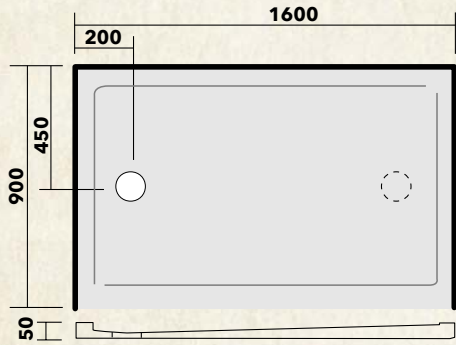

ST1690
3 Sided Left hand/Right hand centre waste

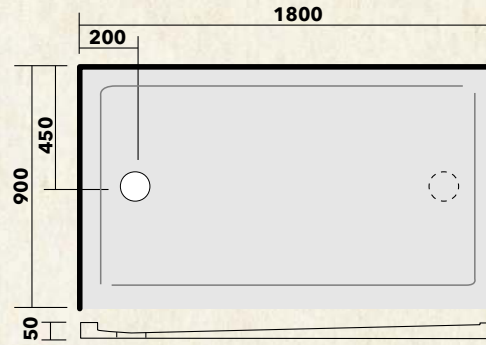

ST1890
3 Sided Left hand/Right hand centre waste

1000 x 1000mm

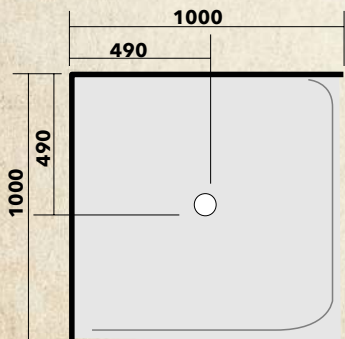

ST21010
2 Sided Centre Waste

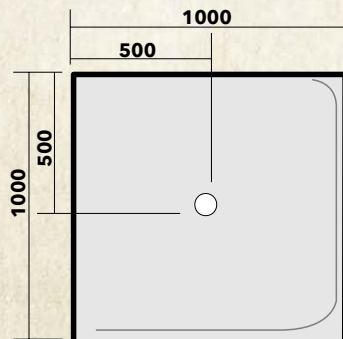

ST31010
3 Sided Alcove Centre Waste

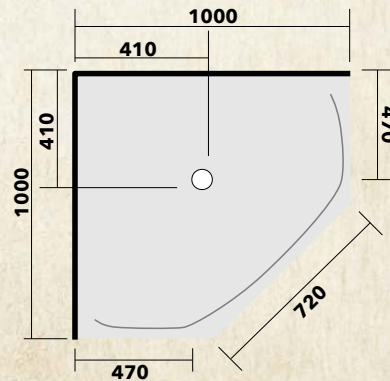

ST4521010
Angle Corner - Centre Waste

NOTES

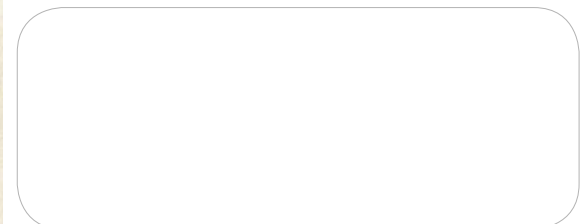



PREMIUM QUALITY
BATHROOMWARE

Since 1853