



Performance is everything.™

User Guide

Vax Careline: AU: 1300 361 505
NZ: 0800 800 900

2 in 1 Steam Cleaner

steam

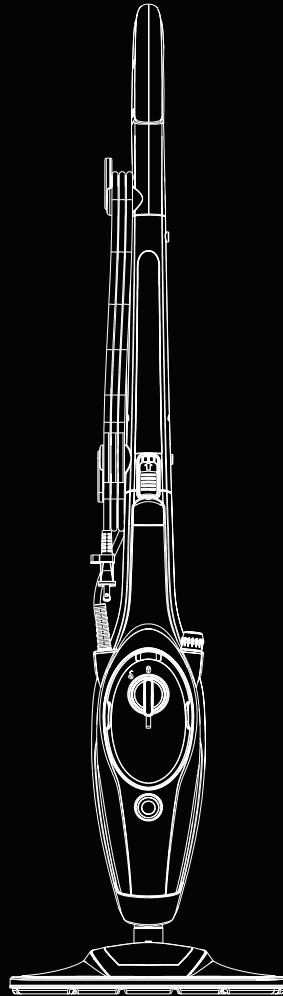

Get Cleaning...

What's your Vax's model number?

VSTDU01600

What's your serial number? (Located on the base of the machine)

Serial number input field consisting of 15 empty square boxes.

Note these down in case you need them in future. Please keep instructions for further use.

vax.com.au

VSTDU01600

Vax Service line: AU: 1300 361 505
NZ: 0800 800 900

General Safety Information

FOR HOUSEHOLD USE ONLY.

When using the steam cleaner, basic safety precautions should always be observed, including the following:

1. Turn off the steam mop controls before disconnecting or connecting from the mains supply.
2. Always unplug the steam mop before connecting or disconnecting accessories.
3. Children should be supervised to ensure that they do not play with the appliance.
4. This appliance is not intended for use by persons (including children) with reduced physical, sensory or mental capabilities, or lack of experience and knowledge, unless they have been given supervision or instruction concerning use of the appliance by a person responsible for their safety.
5. Use only as described in this manual. Use only Vax recommended attachments.
6. Do not use the steam mop if it has been dropped, damaged, left outdoors or dropped into water. Do not use the steam mop with a damaged cord or plug. If the supply cord is damaged, it must be replaced by the manufacturer, its service agent or similarly qualified person in order to avoid a hazard.
7. Do not pull or carry by cord. Do not use the cord as a handle, close a door on the cord or pull cord around sharp edges or corners. Do not run the steam mop over the cord. Keep the cord away from heated surfaces.
8. Do not handle the plug or steam mop with wet hands. Do not use outdoors or on wet surfaces.
9. Do not put any objects into openings. Do not use with any openings blocked and do not restrict steam flow. Keep all openings free of dust, lint, hair or anything that might reduce airflow.
10. Keep hair, loose clothing, fingers and all parts of the body away from openings and moving parts.
11. Do not steam clean harmful or toxic material (chlorine, bleach, ammonia, drain cleaner etc.).
12. Keep cleaning area well lit.
13. Store the steam mop in a cool, dry area.
14. Turn off the on/off switch before unplugging the steam mop.
15. Symbol IEC 60417-5597 (2002-10)  is used on the unit to indicate the following:



WARNING: Danger of Scalding

16. Do not operate the steam mop without water in the tank. Always top up with water in due time and only when the steam mop is switched off and unplugged at the mains.

17. Never fill the tank with anything other than water. Never put additives (such as perfumes, stain removers or products containing alcohol) in the water as they may damage the steam mop or make dangerous to use.

18. Never aim the steam cleaner at people, animals or plants (risk of scalding). The liquid or steam must not be directed towards equipment containing electrical components, such as the interior of ovens.



WARNING: Always switch off and unplug the steam cleaner from the electrical outlet before assembling, opening or emptying the water container, or before connecting/disconnecting the attachments.



CAUTION: The steam cleaner is a very powerful unit. Before plugging the cord into the electrical outlet, make sure the switch is in the 'off' position. Hold the steam cleaner firmly when starting and in use.



IMPORTANT: We recommend the use of a Residual Current Device with a Residual Current rating of 30mA or less.



WARNING: Never leave the steam mop in one spot on any surface for an extended period of time as this may damage the floor surface. Always return the mop back to the resting tray when not in use or when not continuously moving across the floor.



IMPORTANT: This steam mop may not be suitable for all floating floorboards or sealed floors – please check with your floorboard manufacturer first prior to use.

This machine is intended for household use only, and NOT for commercial or industrial use.

PLEASE KEEP THESE INSTRUCTIONS FOR FURTHER USE.

Machine Overview

KEY FEATURES OF THE STEAM MOP

1. Handle
2. Steam release trigger
3. Power cord wrap clips
4. Handy steam cleaner detachment button
5. Water fill cap
6. Water tank
7. Resin filter
8. Power indicator
9. On/off switch for handy steam cleaner
10. Steam rate adjustment knob
11. Main on/off switch
12. Pressure relief valve
13. Mop head
14. Carpet glider
15. Resting tray

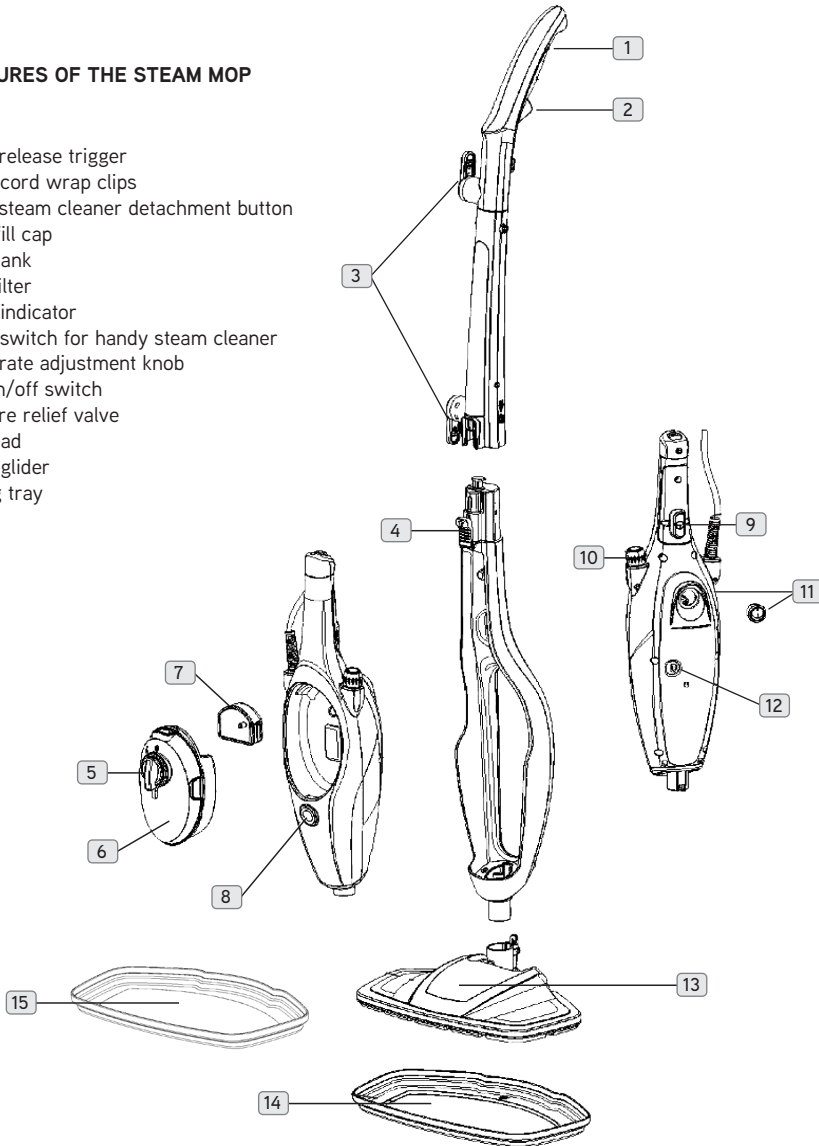

Machine Overview

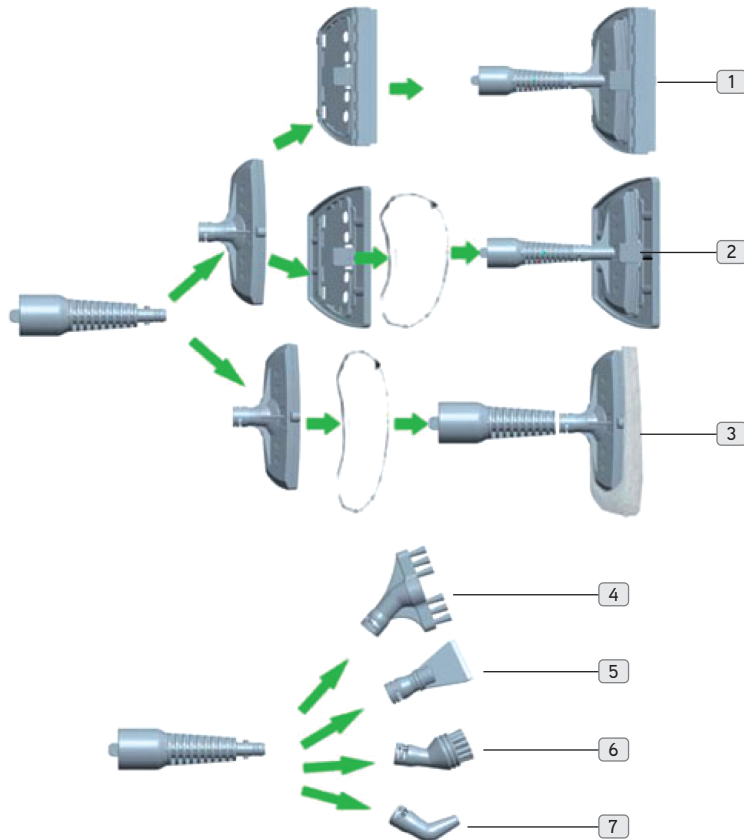

ATTACHMENTS FOR THE HAND STEAM CLEANER

1. Window cleaner. Ideal for window cleaning. CAUTION: Not suitable for tinted windows.
2. Nozzle with cleaning cloth for hard surfaces.
3. Nozzle with cleaning cloth for glass cleaning and hard surfaces.
4. Long brush attachment. To remove dirt, in grooves and crevices.
5. Spatula attachment. To remove stubborn stains, such as lime scale and deposits.
6. Circular brush attachment. To remove stains, for cleaning on tiles, wheel rims, mirrors and non-cold glass surfaces.
7. Nozzle attachment. To clean places that are not readily accessible or crevices.

Operation

Assembling your stick steam cleaner



Insert the handle onto the middle section and screw both parts together.

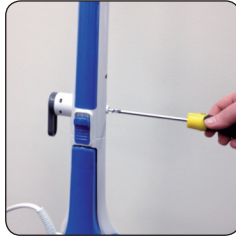

There are 2 screws – one on the side of the unit



and the other inside the cord clip.



Insert the steam floor head at the bottom end of the middle section, you must hear it click into place.

Before you begin cleaning

For best results, thoroughly sweep or vacuum floors prior to cleaning with the steam mop.



WARNING: To reduce the risk of personal injury, unplug the steamer when assembling the unit.



Remove the clean water tank by pressing the tank release clip.



Twist the cap anticlockwise to remove.





Fill the tank with 400ml of water and replace the water cap. Tighten by twisting clockwise. **DO NOT OVERFILL.**

Replace the clean water tank, clicking into place making sure the hard water filter is in place.

NOTE: In hard water areas, or to prevent calcium and mineral deposits from accumulating on the heating element and mop head, you may use distilled or demineralised water in place of tap water.

Operation

Attaching the microfibre cleaning pads

-  **WARNING:** To reduce the risk of personal injury, unplug the steamer when assembling the accessories.
-  **WARNING:** Never use the steam mop without the microfibre cleaning pad correctly attached to the floor head.
-  **IMPORTANT:** Place the steamer on the resting tray whilst the steam is heating and when the product is not moving continuously on the floor.



Place the microfibre cleaning pad over the floor head.
Tighten the drawstring so the microfibre cleaning pad is fitted securely.







NOTES:

1. Always check the floor cleaning cloth for wear before each use. It must not be used if it is visibly worn or damaged. This could result in damage to your floor covering.
2. The steam cleaner should only be used with floor cleaning cloths specifically manufactured for it.
3. When cleaning, ensure that the floor cleaning cloth is firmly attached to the cleaning head in order to avoid damage to the appliance or floor covering.
4. Never direct the steam at people, animals or equipment which contains electrical components (e.g. oven interiors, refrigerators, switches and lights, microwaves etc.).
5. Beware – risk of scalding! Never touch the appliance's cleaning head/attachment while in use.
6. The floor cleaning cloth can remain very hot for a short time after use. If you want to remove it, wait until it has cooled down and the appliance is no longer emitting any steam.
7. Put the appliance back in its place only when it has completely cooled down and empty any water from the tank.

-  **ATTENTION:** On surfaces that have been treated with wax, the wax may be removed by the heat and steam action. Do not use on unsealed wood floors or let unit stand on any wood floor for an extended period of time. This could cause the wood grain to rise. When using on vinyl, linoleum or any other heat sensitive floors, use extra caution. It is therefore recommended that a sample is carried out on an isolated area of the floor. It is also recommended that you check the use and care instructions of the surface from the floor manufacturer to ensure suitability to steam cleaning.

Operation

Steam cleaning hard floors

-  **WARNING:** Never leave the stick steamer in one spot on any surface for an extended period of time as this may damage the floor surface. Place on the resting tray whilst the steam is heating and when the product is not moving continuously on the floor.
-  **WARNING:** Your stick steamer should only be used on tiles, lino or sealed wood flooring. Do not use on laminated flooring and if using the product on floating floor boards – check with the manufacturer of this flooring before use if it is suitable.
-  **WARNING:** Never use the steam stick without the microfibre cleaning pad properly attached to the floor head.
-  **WARNING:** To reduce the risk of personal injury, unplug the steamer when assembling the accessories.
-  **IMPORTANT:** Check the water tank viewing window to ensure there is adequate water in the water tank.
-  **IMPORTANT:** Do not put solutions or detergents into the water tank. This machine operates with water & steam only.

1. Plug into mains and switch power button 'on' at the back of the handheld. Steam takes approx. 30 seconds.



To recline the unit place foot on floor head and tilt handle.







To produce steam squeeze the trigger. A hissing noise will be heard as the steam begins. Steam will wet the microfibre cleaning pad.



Move the steam stick slowly backwards and forwards across the floor paying particular attention to high traffic areas.

Operation

Refreshing carpets

-  **WARNING:** Your Steam Mop is designed to refresh carpets or rugs that will withstand high heat. Be sure to check the Use and Care Instructions from the carpet manufacturer before steam cleaning.
-  **WARNING:** The carpet glider accessory is for use on carpeting and rugs only. Use of the carpet glider on other floor will cause streaking and possible scratching of the floor's surface.
-  **IMPORTANT:** Never use the Steam Mop without the microfibre cleaning pad properly attached to the mop head.
-  **IMPORTANT:** Check the water tank viewing window to be sure there is adequate water in the water tank.
-  **CAUTION:** The Steam Mop emits steam and creates moisture. If the Steam Mop operates too long in one place, water marks can result.

For best results, thoroughly vacuum the carpets or rugs prior to steam cleaning.

1. Place the mop head (with microfibre cleaning pad in place) on top of the carpet glider.
2. Do not attempt to use the Steam Mop on carpet/rug surfaces without the carpet glider in place!



Attach carpet glider attachment to floor head by pushing the steam stick onto it.



To recline the unit place foot on floor head and tilt handle.



To produce steam squeeze the trigger.







Move the steam stick slowly backwards and forwards across the floor paying particular attention to high traffic areas.

-  **WARNING:** Never leave the Steam Mop in one spot on any surface for an extended period of time as this may damage the floor surface. Always return the mop back to the resting tray when not in use or when not continuously moving across the floor.

Operation

Steam cleaning with the Handheld Steamer

-  **WARNING:** Never leave the hand steamer in one spot on any surface for an extended period of time as this may damage the surface.
-  **WARNING:** Your steamer should only be used on tiles, lino or sealed wood flooring. Do not use on laminated flooring and if using the product on floating floor boards – check with the manufacturer of this flooring before use if it is suitable.
-  **WARNING:** To reduce the risk of personal injury, switch off and unplug the steamer when assembling the accessories.
-  **IMPORTANT:** Check the water tank viewing window to ensure there is adequate water in the water tank.
-  **IMPORTANT:** Do not put solutions or detergents into the water tank. This machine operates with water & steam only.

THE FOLLOWING ATTACHMENTS FOR THE HAND STEAM CLEANER

1. Window cleaner. Ideal for window cleaning.
CAUTION: Not suitable for tinted windows.
2. Nozzle with cleaning cloth for hard surfaces.
3. Nozzle with cleaning cloth for glass cleaning and hard surfaces.
4. Long brush attachment. To remove dirt in grooves and crevices.
5. Spatula attachment. To remove stubborn stains, such as lime scale and deposits.
6. Circular brush attachment. To remove stains, for instance on tiles, wheel rims, mirrors and non-cold glass surfaces.
7. Nozzle attachment. To clean places that are not readily accessible or crevices.

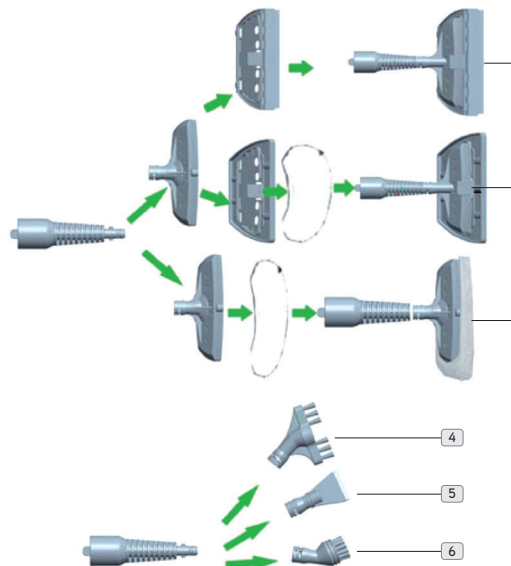

Operation

Steam cleaning with the Handheld Steamer (cont)

NOTE: Because of the copper ball in the water tank, the appliance is suitable for horizontal use, for the cleaning of wall tiles.

1. Remove the handheld steamer from the stick steamer by sliding the release switch in an upwards motion.



2. Attach the connection nozzle to the handheld steamer.
3. Select an attachment that is suitable for the task at hand. Push small tools onto the concentration nozzle and twist clockwise.

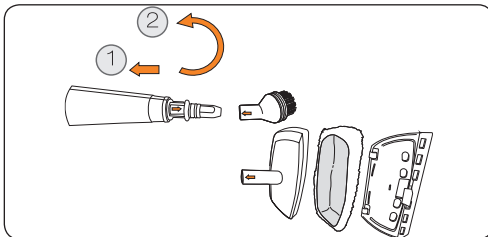

4. Push small tools onto concentration nozzle aligning arrows. Twist clockwise to fit.



NOTE: Concentration nozzle must be attached before fitting the small tools.

Operation

Accessories – Using the small tools

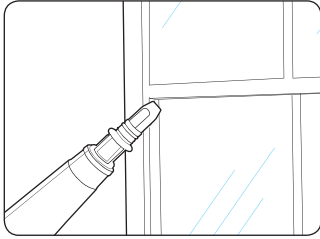

Concentration nozzle

Use to remove soap scum in baths and shower enclosures and to clean heavily soiled areas in kitchens.

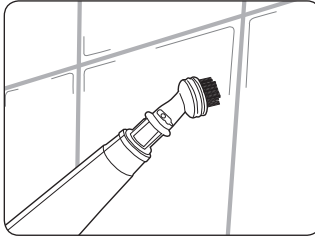

Brush

Agitate stubborn grease and grime.

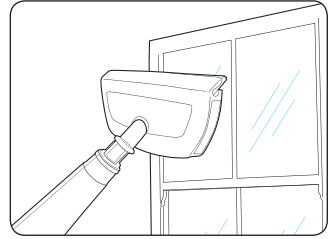

Window tool

Great for leaving your windows and mirrors gleaming and smear-free.

Use with the cloth provided.

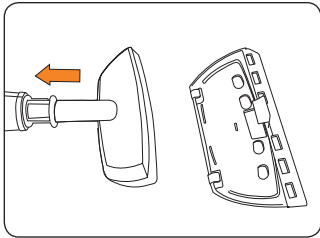

Upholstery tool

Unclip the window tool from the upholstery tool.

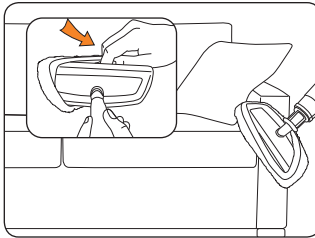

Upholstery tool

Attach the upholstery cloth to the upholstery tool for use on sofa and chair fabrics.



IMPORTANT: Test for colour fastness in a small hidden area of upholstery to check for colour removal before use.

Maintenance (Keep your Vax as good as new)

Cleaning cloths

Cloths can either be washed by hand or machine washed at 30° C with mild detergent. Never use bleach or fabric softener. Do not tumble dry.

To avoid passing or picking up lint from the cleaning pads, wash the microfibre cleaning pads separately or place them in a garment bag.

 **IMPORTANT:** Wash microfibre cleaning pads regularly. As with any fabric, dirt particles can cause the fibres to break down. Therefore regular cleaning will help preserve the cleaning efficiency of the microfibre cleaning pads.

As the microfibre cleaning pad is used, sometimes a thread will loosen or pull out. This is normal. Never pull loose threads as this can cause the weave to come undone. Simply trim any loose threads with a pair of sharp scissors.

Storage

 **IMPORTANT:** The floor cleaning cloth can remain very hot for a short time after use. When removing the cloth, wait until it has cooled down and the appliance is no longer emitting any steam.

 **IMPORTANT:** Ensure the steam cleaner has completely cooled down before storing.

 **IMPORTANT:** Empty water from the water tank before storage.

 **IMPORTANT:** Never store the Steam Mop while it is still plugged in. Remove the plug from the electrical outlet and wrap cord for storage.

 **IMPORTANT:** Store upright in a protected, dry area. Keep water fill cup and funnel handy for future use.

 **IMPORTANT:** Never immerse the appliance in water – use a damp cloth to clean if necessary.

 **IMPORTANT:** Do not use any corrosive or abrasive cleaning agents – these could damage the surface.

 **IMPORTANT:** Keep the appliance out of reach of children.

Maintenance (Keep your Vax as good as new)

Replacing the hard water filter

 **IMPORTANT:** The condition of the filter affects the performance of your machine. Check and change filter regularly (depending on level of use).

Your machine is fitted with a hard water filter. If you live in an area of hard water the filter will discolour/darken over time. Depending on water hardness and/or frequency of use the filter should be changed every 6 months.



FAQ's



WARNING: To reduce the risk of personal injury, unplug the steam cleaner before performing maintenance/troubleshooting checks.



CAUTION: Prior to troubleshooting isolate the unit by removing the cord from the power socket.

If the appliance does not function properly, please check first of all whether you can solve the problem yourself. Do not attempt to repair a defective appliance yourself.

Problem	Solution
LED is not on	Ensure the steam mop power cord is correctly plugged into power outlet and power trigger is turned on. Ensure circuit breaker is operational. Try operating the steam mop from another power outlet.
Copper ball does not sink in the water tank	Wiggle it and make sure the copper ball is still in the water tank.
Steam mop will not produce steam	Ensure the water tank has correct level of water.
Pale residue left on the floor	Caused by leaving the steam mop in the same position for too long. Can be removed with household white vinegar or a decalcifying product. Alternatively reheat the area for one minute and residue should be removed. CAUTION: do not overheat area.
Steam mop steams water instead of steam	Let the steam cleaner warm up for 30 seconds before you put the switch into action.
Steam mop drips	Ensure: - if the filter and/or water tank is assembled well (must be fitted properly) - if the water tank or the filter drips (this may indicate a small crack)
There is no steam	Make sure the steam switch is functioning properly. Check for water in the water tank. Check if the filter is calcified (very dark coloured) and must be renewed.

we're here to help

Instead of taking me back to the shop, simply call:

AU: 1300 361 505

NZ: 0800 800 900

vax.com.au

This does not affect your statutory rights

Other Information

Vax Service & Help

Vax Careline:

Australia 1300 361 505

New Zealand 0800 800 900

Monday-Friday 8.30am to 5.00pm

If you have queries or concerns about using your Vax, call the Vax Careline. Calls are charged at the standard local rate. Please make a note of the serial number and model number of the vacuum cleaner before calling.

For the nearest Service Agent, please call the Vax Customer Careline or visit vax.com.au

Technical Specification

Voltage: 220-240V ~50Hz

Wattage: 1400W – 1600W

Water tank capacity: 400ml

Cord length: 7m

Weight: 2.6kg

Heating time: 30 seconds

Subject to technical change without notice.



Indoor
Use



Read
Instructions



Waste electrical products should not be disposed of with household waste. Please recycle where facilities exist. Check with your Local Authority or retailer for recycling advice.

Notes

Notes

Notes



Performance is everything.™

Distributed by Techtronic Industries Pty. Ltd.
Level 1, 660 Doncaster Road, Doncaster, Australia 3108.
www.vax.com.au Service Line: AU: 1300 361 505 / NZ: 0800 800 900